

Förrad Emelie
Art. Nr. 3420000
1/7

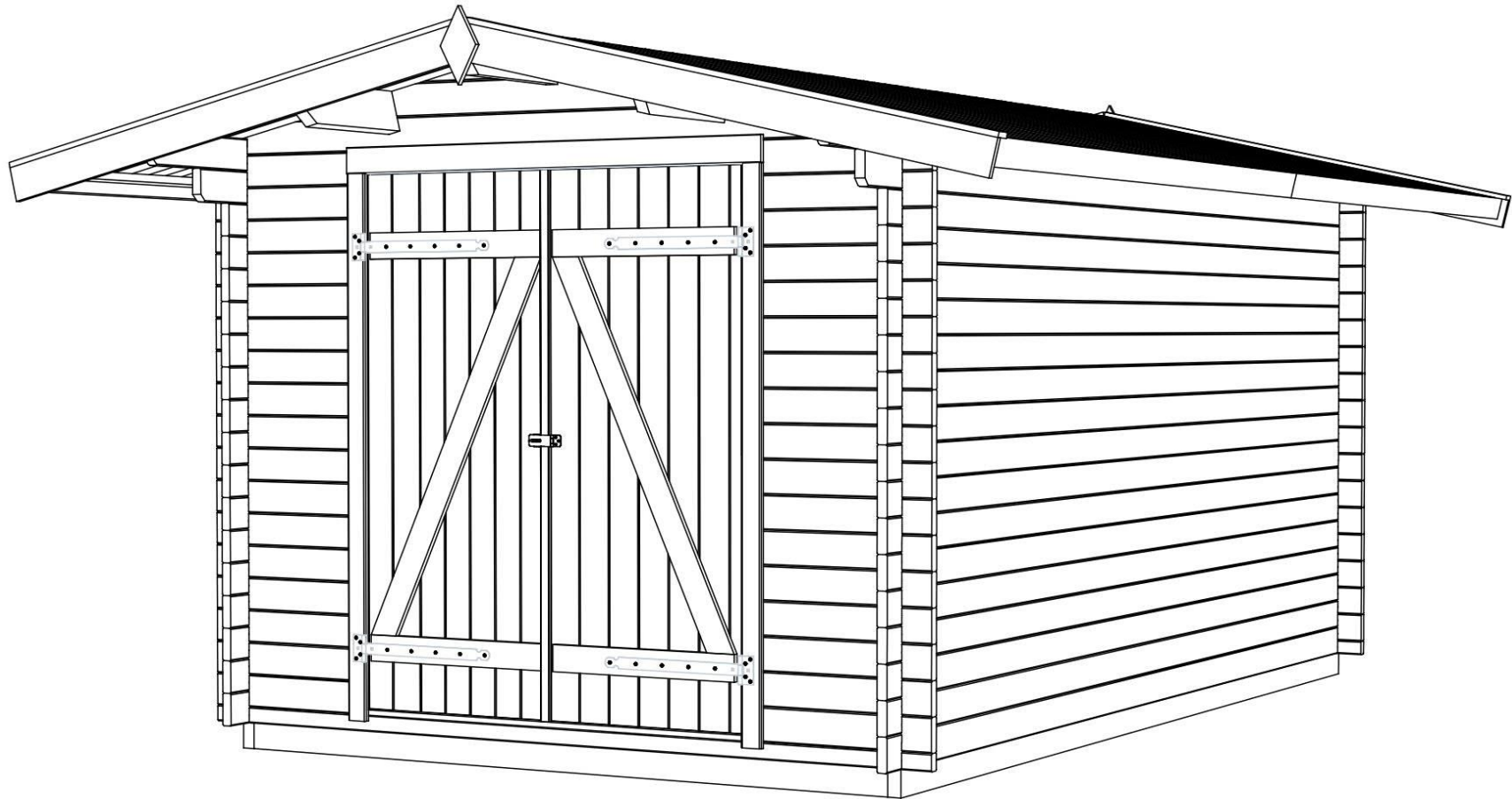

Art. Nr. 3420000

Groundplan - Grundplan - Plan de masse - Planimetria - Plattegrond
- Põhiplaan

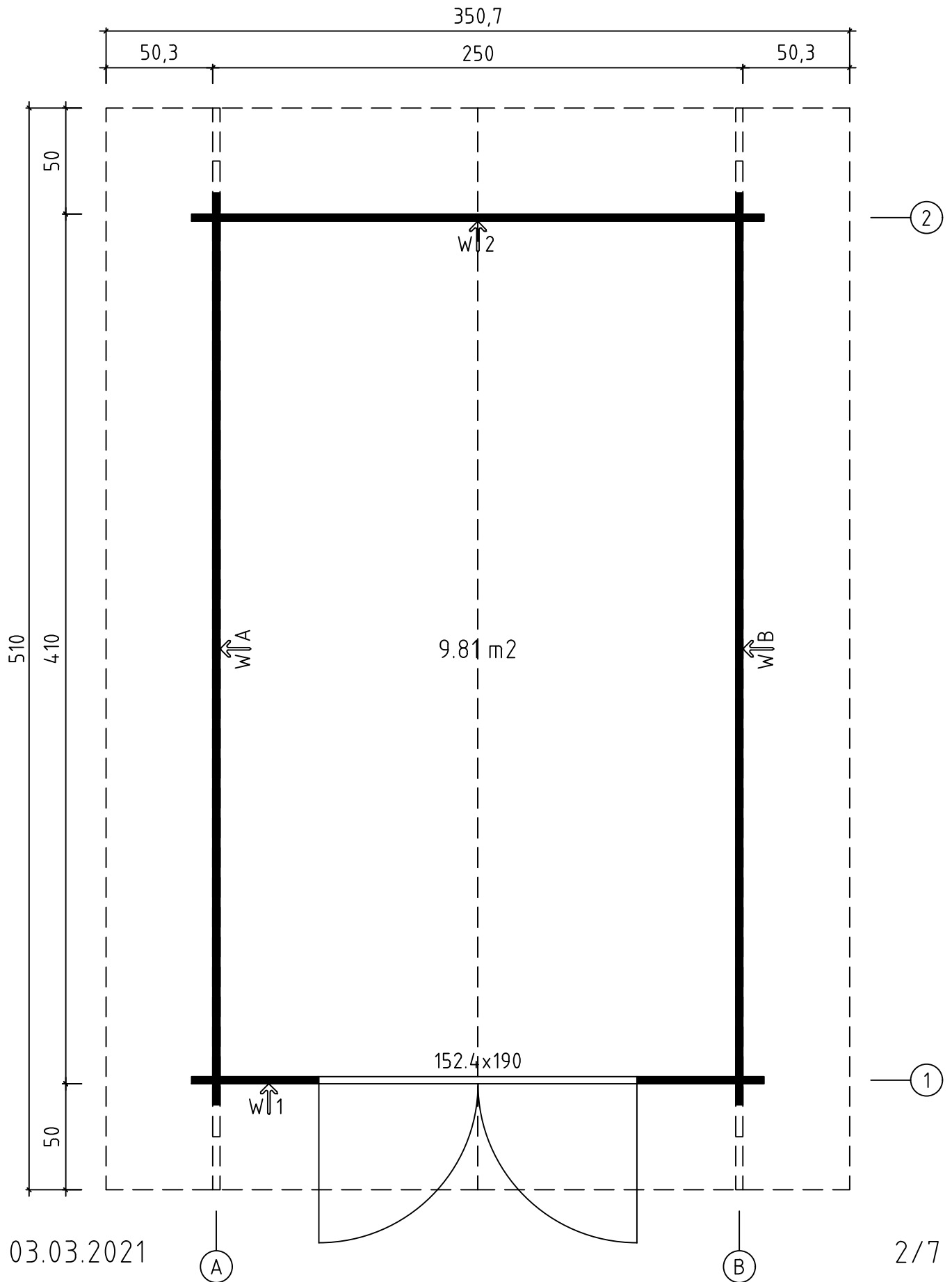

Art. Nr. 3420000

Foundation - Fundament - Fondation -
Fondamenta - Fundering - Immutatud alusraam

Floor boards - Fussbodenbretter - Plan pose plancher -
Pavimento - Vloerhout - Põrandalaudis

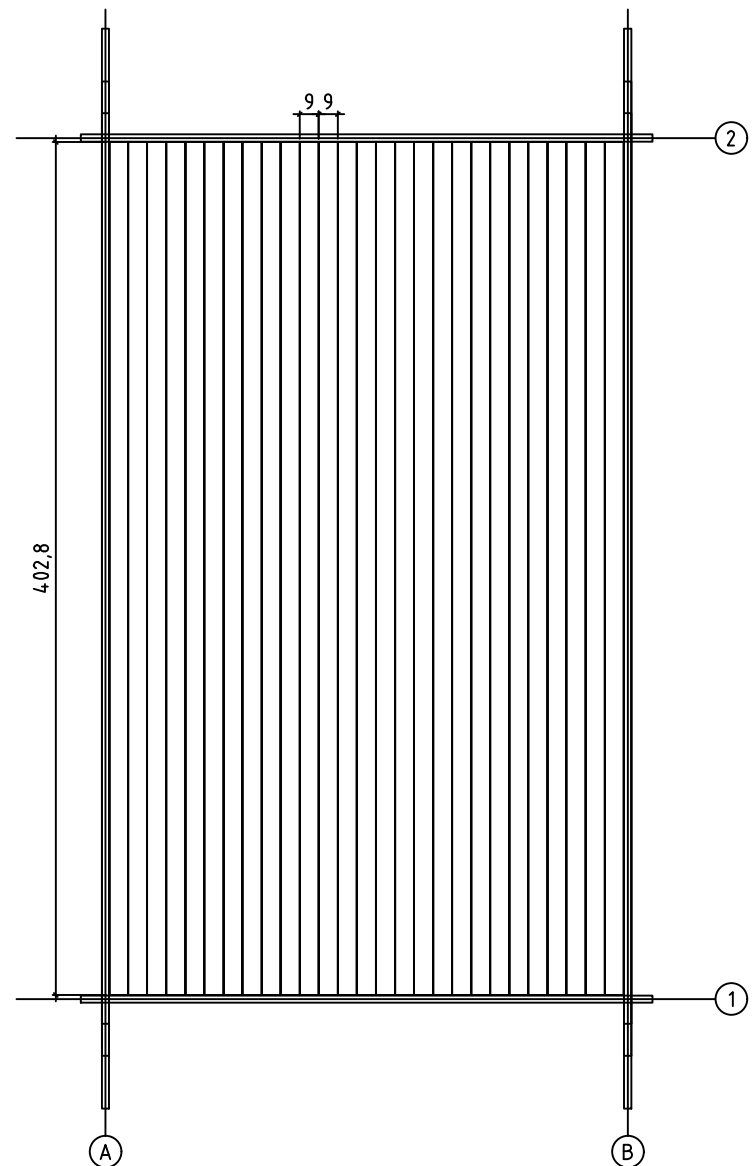
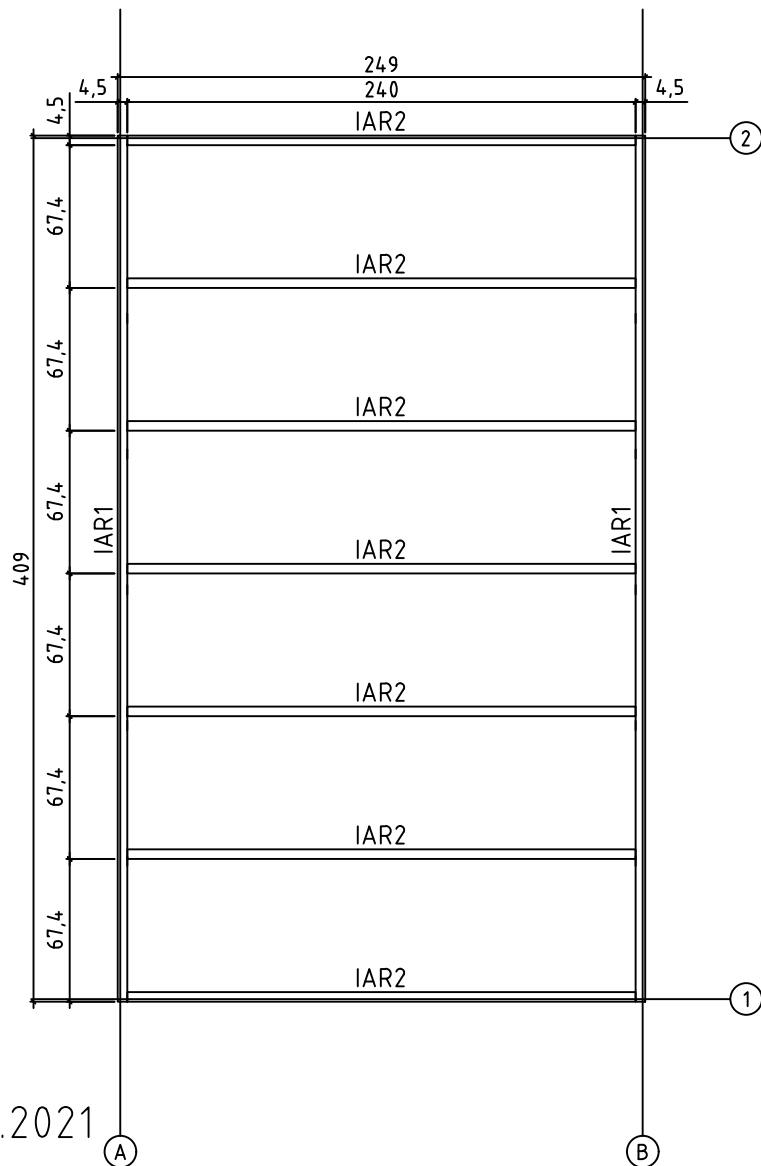







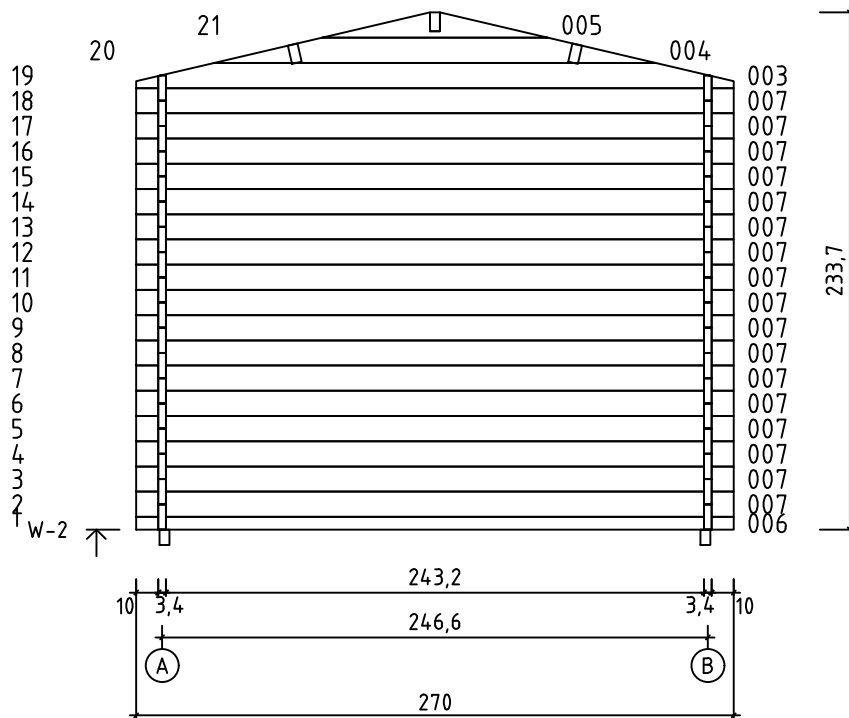
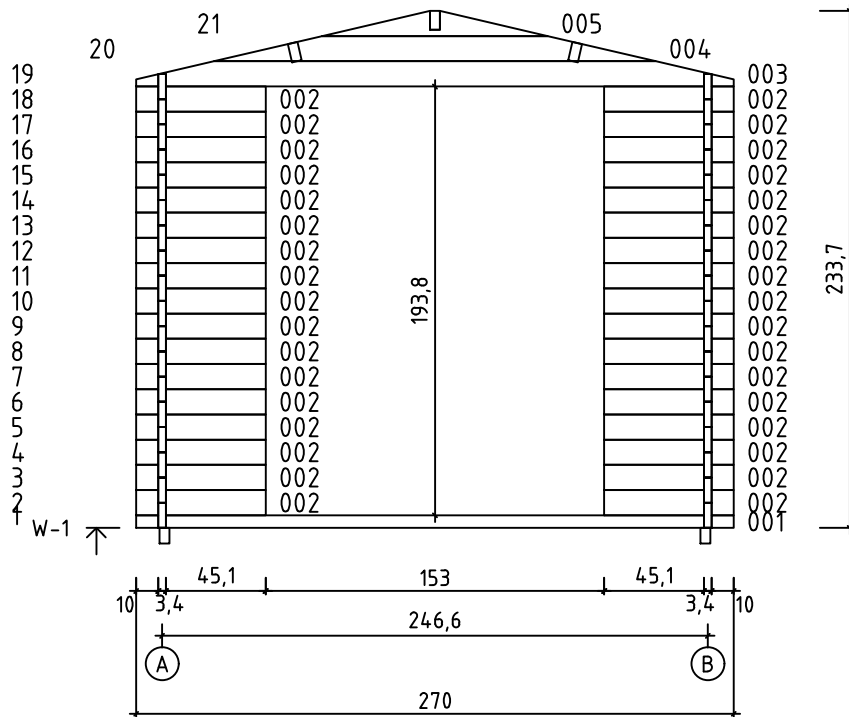

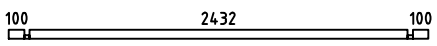
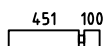
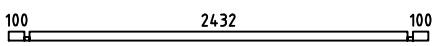
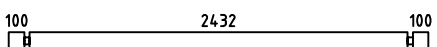
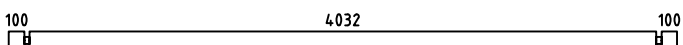
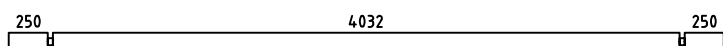
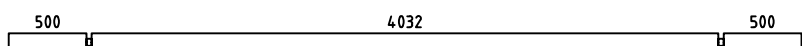
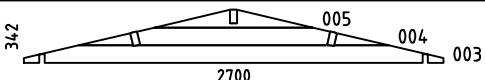
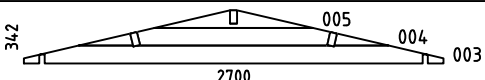

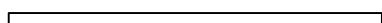
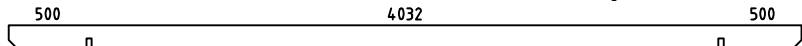



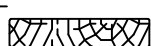

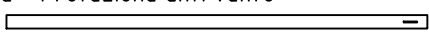
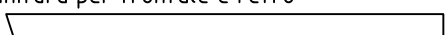
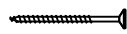
03.03.2021

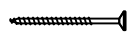
3/7

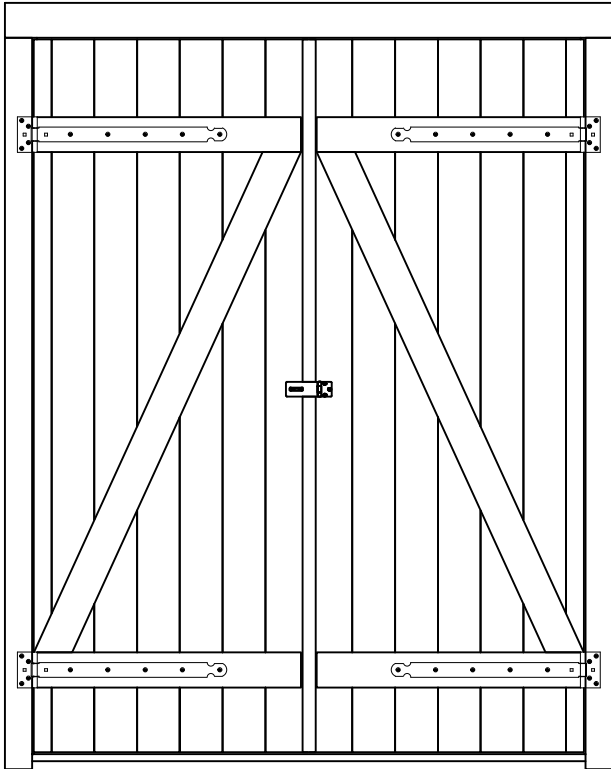
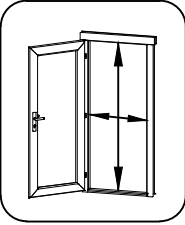
Art. Nr. 3420000



Pos	03.03.2021 Piece list - Stückliste - Liste des pièces - Elementi - Stuklijst - Tükitalabel Art. Nr. 3420000 6/7	Q	P (mm)	L (mm)
001		1	34x57	2700
002		34	34x114	585
006		1	34x57	2700
007		17	34x114	2700
008		32	34x114	4300
009		2+1	34x114	4600
010		2	34x120	5100
W1-1		1		
W2-1		1		
IAR1	Foundation - Fundament - Fondation - Fondamenta - Fundering - Immutatud alusraam 	2	45x90	4090
IAR2	Foundation - Fundament - Fondation - Fondamenta - Fundering - Immutatud alusraam 	7	45x90	2400
A-PR1	Roof beam - Dachbalken - Panne de toit - Perlina del tetto - Gordingen / dakbalk - Pärlin 	3	44x140	5100
	Floor boards - Fussbodenbretter - Lame de plancher - Pavimento - Vloerhout - Põrandalaud 	27+1	90x18	4028
	Roof boards - Dachbretter - Voliges - Perlina per tetto - Dakhout - Katuselaud 	114	90x18	1800
	Floor fillet - Fussbodenleiste - Corniere de finition du plancher - Finitura per pavimento (battisco pa) - Vloerafwerklijst - Põrandaliist 		18x18	13
	Roofing felt fillet - Dachpappenteiste - Baguette de fixation du feutre bitumeux - Asse per fissaggio guaina bituminosa - Afdeklijst asfaltpapier - Katusepapiilist 	4	18x58	1850
TB-1	Fascia board - Traufbrett - Bandeau de toit - Finitura lati tetto - Gevellijst - Räästalaud 	4	18x90	2550
DRV-1	Roof edge reinforcement - Dachrandverstärkung - Corniere de renfort de bord de toit - Rinforzo x tetto - Dakrand versterking - Räästatugevdus 	4	28x34	2550
KFS-1	Storm protection - Sturmleiste - Latte anti-tempete - Protezione anti vento - Stormverankering / beveiliging - Tormikinnitusliist 	4	22x45	2050
	Gable moulding - Giebelleiste - Planche de rive - Finitura per frontale e retro del tetto - Gevellijst - Viilulaud 	4	18x120	1850
HS8	Screw for gable segment - Schrauben für deckblatt - Vis pour fixation losange de finition - Viti x frontali tetto - Schroef voor gevelpunt segment - Kruvi rombile 	4	3.5x35	
HS9	Screw for gable moulding - Schrauben für giebelleiste - Vis pour fixation planche de rive - Vite per fissare finiture davanti e dietro del tetto - Schroef voor gevellijst - Kruvi viilulauale 	24	3.5x50	
HS12	Screw for fascia boards - Schrauben für traufbretter - Vis pour fixation bandeau de toit - Viti x striscia del tetto - Schroef voor gevellijst - Kruvi räästalauale 	24	4x40	

Pos	03.03.2021	Delförteckning - Liste over deler - Stykliste - Osaluettelo 1524x1900 TUL.1.100.IVP.MYc TZ+R	1/1	Q	P (mm)	L (mm)
						
						 1424x1832 mm
HS7	Skruv för hänglåsets spärr - Skrue for hængelåsens hengsel - Skrue til hængelåsens beslag - Riippulukon salvan ruuvi		7	3.5x20		
HS4	Skruv för golvläkt - Skrue for dørlist - Skrue til dørliste - Øvilistan asennusruuvi		5	3x30		
HS16	Skruv för dörrkarm - Skrue for dørstolpe - Skrue til dørkarm - Oven karmin ruuvi		4	5x90		
	Skruv för dörrgångjärn - Skrue for dørhengsler - Skrue til dørhængsler - Oven saranan ruuvi		36	6x40		
TT	Gångjärn för dörr - Dørhengsler - Dørhængsler - Oven sarana		4			
	"Hänglåsets spärr - Hængelåshaspe - Hængelåsoverfald		1			