

Views and ground plan - Fasader och grundplan - Julkisivut ja pohjapiirustus

Roof MAX 100kg/m²

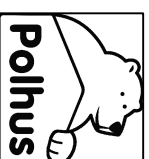
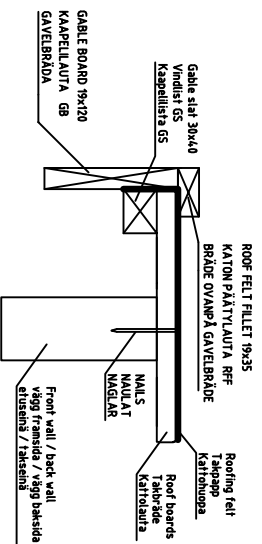
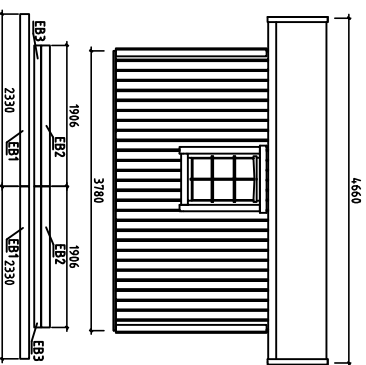
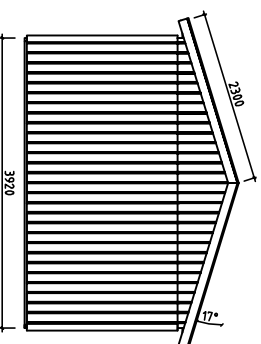
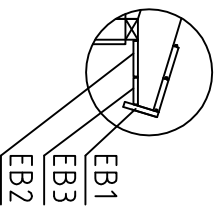
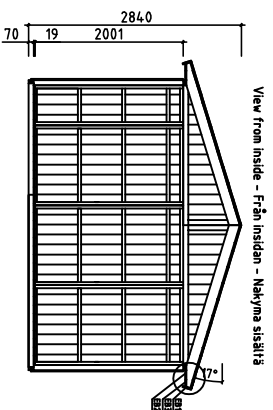
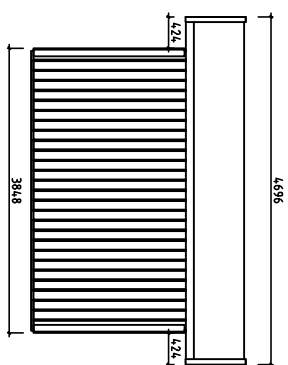
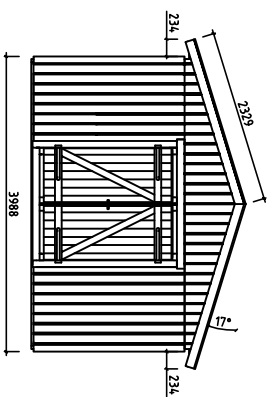
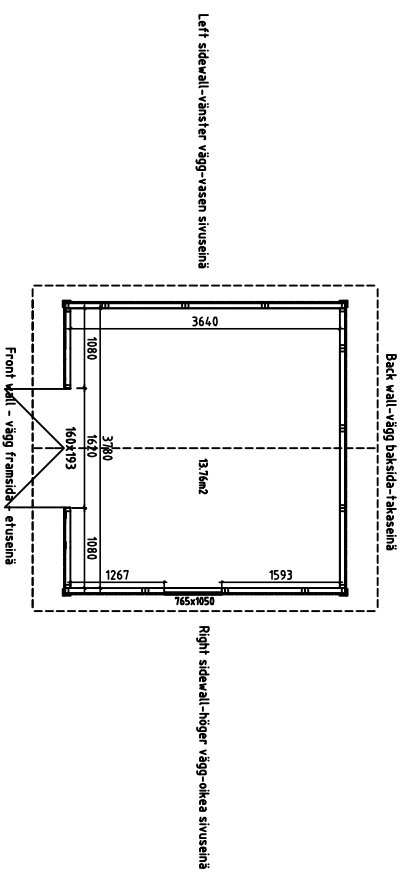

House	FE3838-16 Göte	Sheet	1
Drawing		Scale	1:100
Material		Date	26.01.2016
Drawer	K.K.	File	FE3838-16 Göte.dwg

Overview description of the manual - Översikts beskrivning för montering - Kokoonpano - ohjeiden kuvaminen

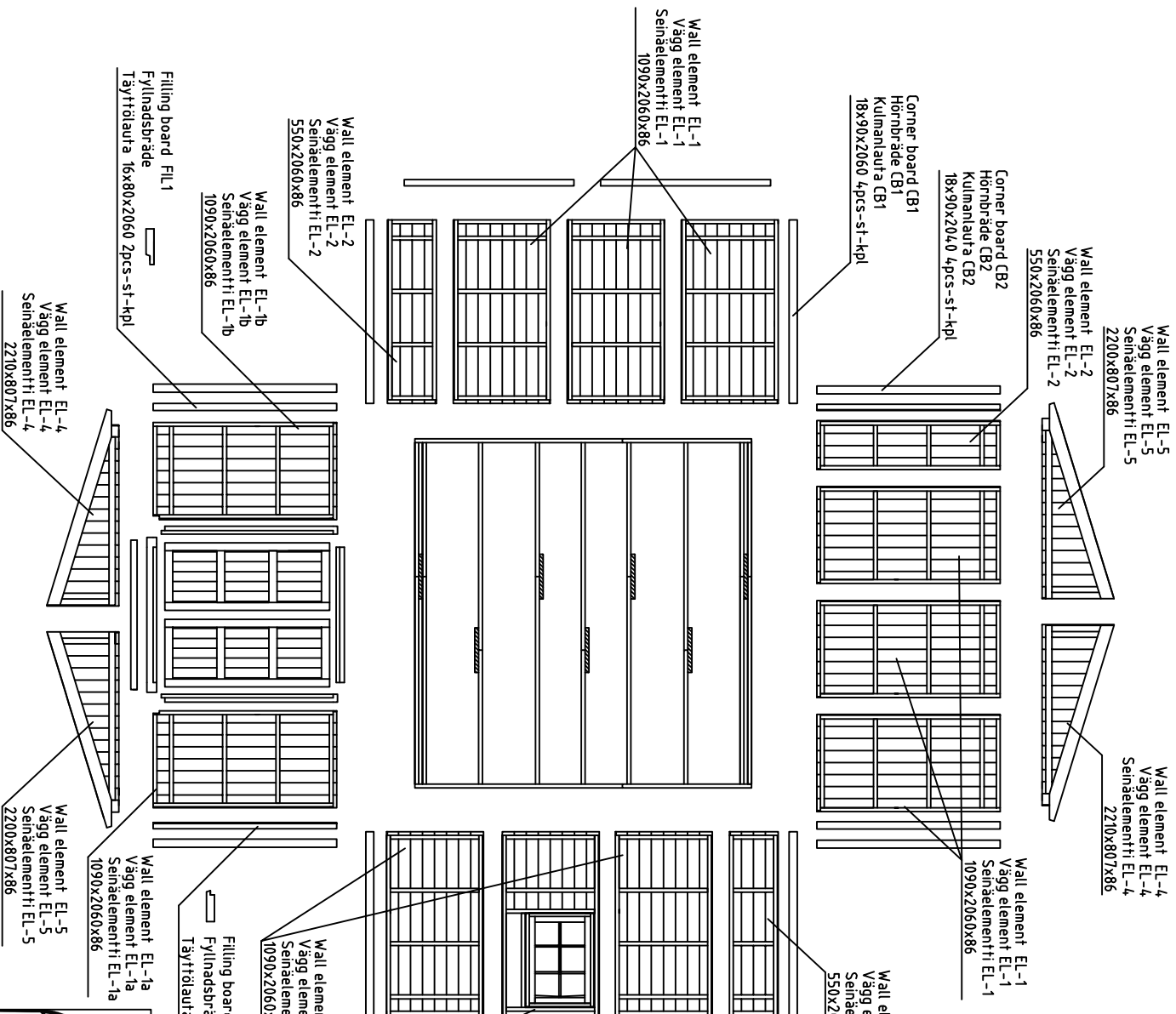

2330	Roofboard 4,4pcs (19x114) or 5,6pcs (19x88)	R1
1880	Takbräde 4,4st (19x114) och 5,6st (19x88)	
1390	Katrollautra 4,4kpl (19x114) tai 5,6kpl (19x88)	
2330	Roofboard 20pcs (19x114) or 26pcs (19x88)	R2
1300	Takbräde 20st (19x114) och 26st (19x88)	
2330	Katrollautra 20kpl (19x114) tai 26kpl (19x88)	
1900	Floorboard 40pcs (19x114) or 52pcs (19x88)	R3
1900	Takbräde 40st (19x114) och 52st (19x88)	
2330	Katrollautra 40kpl (19x114) tai 52kpl (19x88)	
1300	Floorboard 34pcs (19x114) or 43pcs (19x88)	F1
2330	Golvbräde 34st (19x114) och 43st (19x88)	
1300	Lattialautra 34kpl (19x114) tai 43kpl (19x88)	F2
1900	Floor fillet 8pcs 19x35	
1900	Golvlist 8st 19x35	FF
2330	Lattialista 8kpl 19x35	
2293	Gable board 4pcs 19x120	GB
2300	Gavelbräde 4st 19x120	
2291	Kaapellautra 4kpl 19x120	
2330	Gable slat 4pcs 30x40	GS
2330	Vindlist 4st 30x40	
2330	Kaapellista 4kpl 30x40	
2330	Roof felt fillet 4pcs 19x35	
1906	Bräde ovanpå gavelbräde 4st 19x35	RFF
2330	Katron pätyläutra 4kpl 19x35	
1906	Eave boards 4pcs 19x120	EB1
1906	Takfotsbräde 4st 19x120	
1906	Räystäslautra 4kpl 19x120	EB2
1906	Eave boards 4pcs 19x90	EB3
1906	Takfotsbräde 4st 19x90	
1906	Räystäslautra 4kpl 19x90	

Side wall connecting beam SCB
Bjälkar för sidovägg
sammanslagning
Sivuseinä yhdistämisspalkit
70x4,3x1906 4pcs-st-kpl

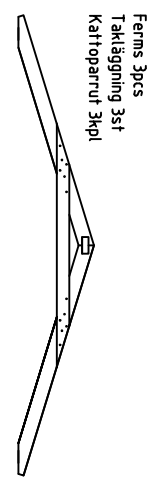

Polhus

House	FE3838-16 Göte	Sheet	2
Drawing		Scale	1:35
Material		Date	26.01.2016
Drawer	K.K.	File	FE3838-16 Göte.dwg

Installation of floorbeams and floorboards - montering av golvbjälkar samt golvräddor - lattialautojen asentus

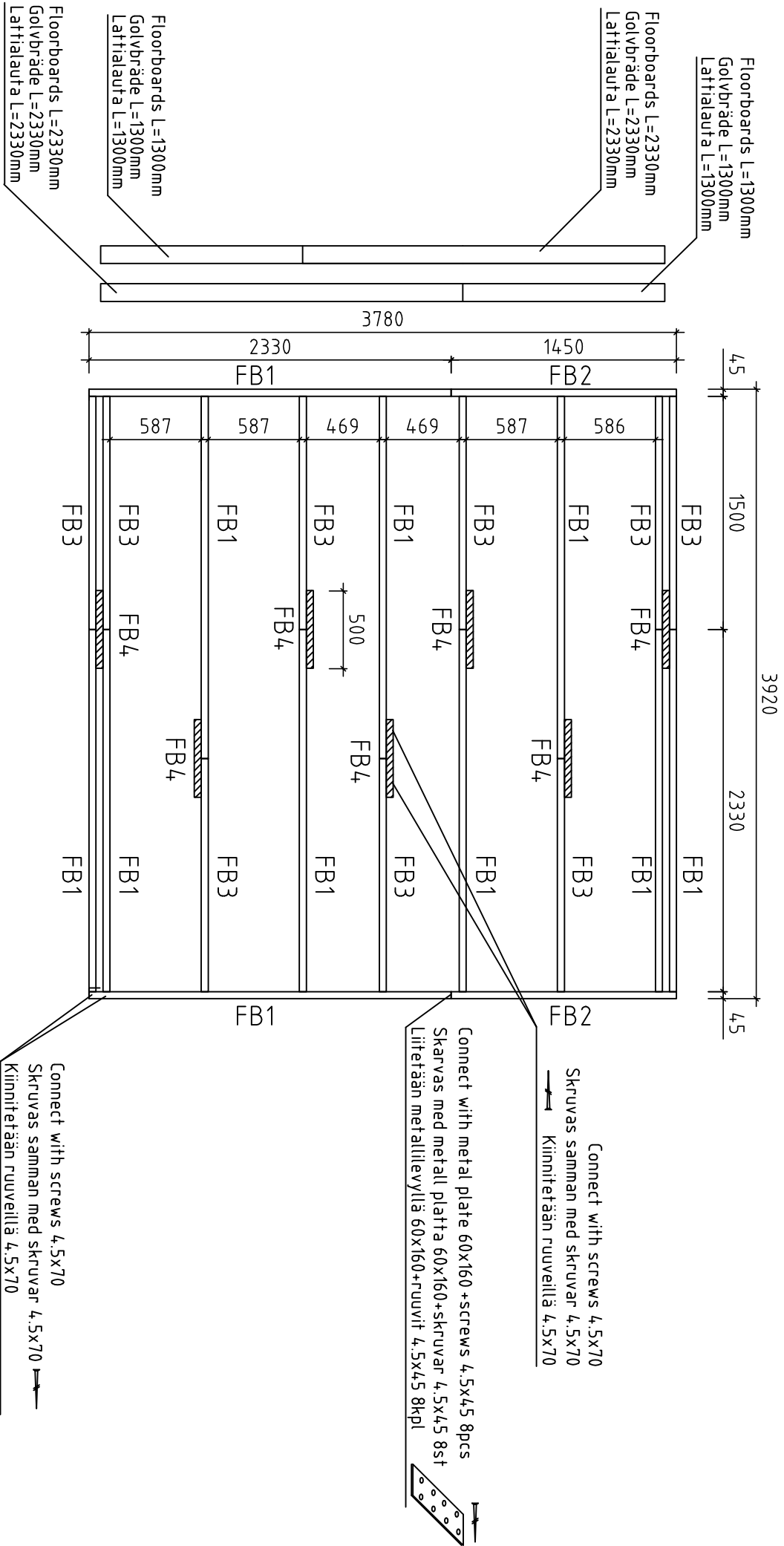

- NB!!! Change the floorboard positions after every row
- NB!!! Skarva golvräddorna olika efter varje rad
- NB!!! Muuta lattialautojen sijaintia jokaisen rivin jälkeen

House	FE3838-16 Göte	Sheet	3
Drawing	Floorbeams-lattialautojen-golvbjälkar	Scale	1:35
Material	4,5x90	Date	26.01.2016
Drawer	K.K.	File	FE3838-16 Göte.dwg

Installation of wall element EL-1b - montering av vägg element EL-1b - seinäelementin EL-1b asennus
(Front wall - vägg framsida - etuseinä)

View from inside - Från insidan - Näkymä sisältä

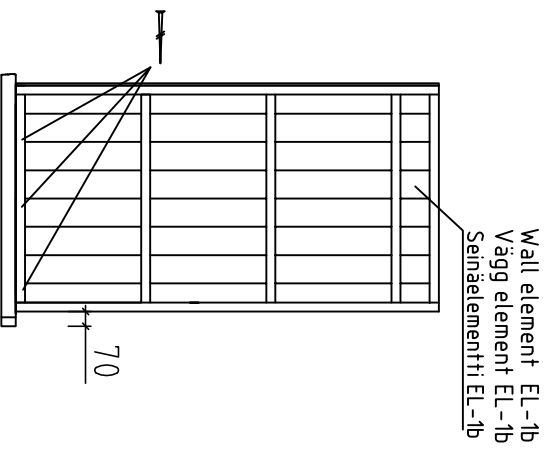

Fix wall element EL-1b with screws
4.5x70 into floorbeam
Fixera vägg element EL-1b med skruvar
4.5x70 i golvväljke
Kiinnitä seinäelementti EL-1b ruuveilla
4.5x70 lattiapalkkin

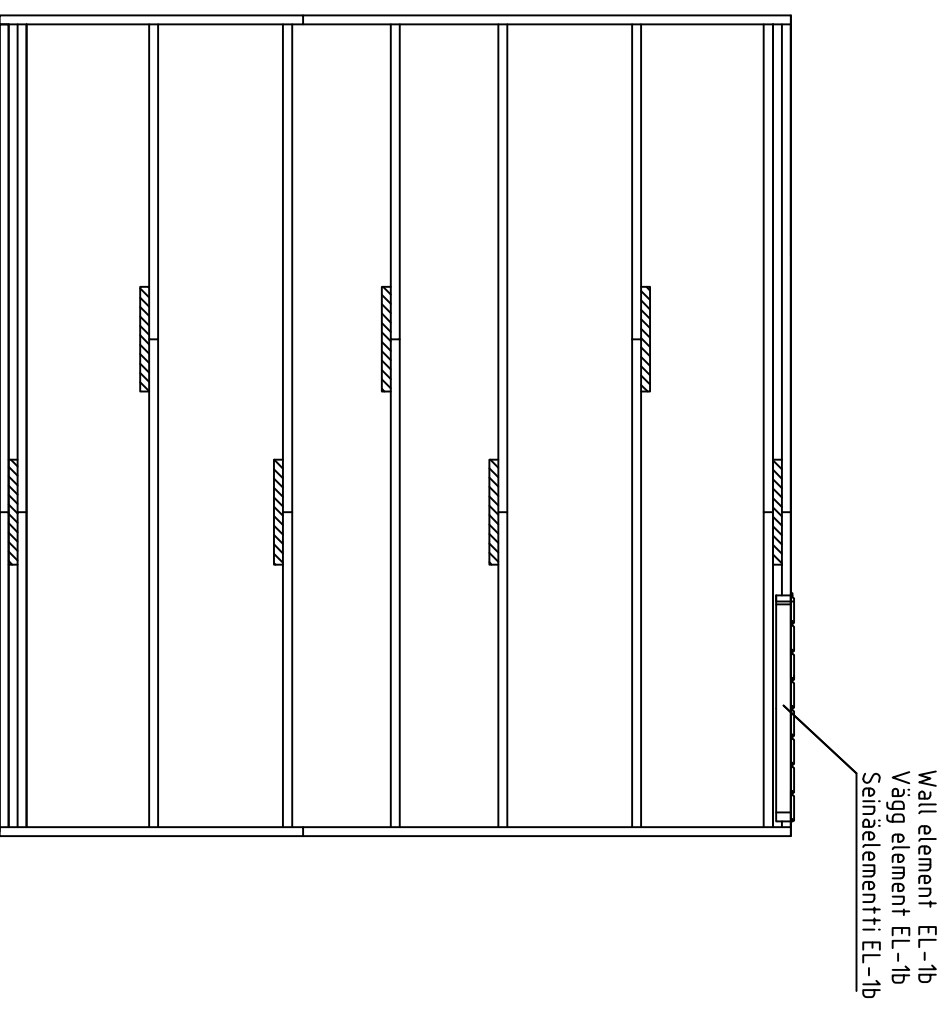

 Polhus		House	FE3838-16 Göte	Sheet	4
		Drawing		Scale	1:35
		Material		Date	26.01.2016
Drawer	K.K.	File	FE3838-16 Göte.dwg		

Installation of left sidewall – montering av vänster sidovägg – vasen sivuseinä asennus

View from inside – Från insidan – Näkymä sisältä

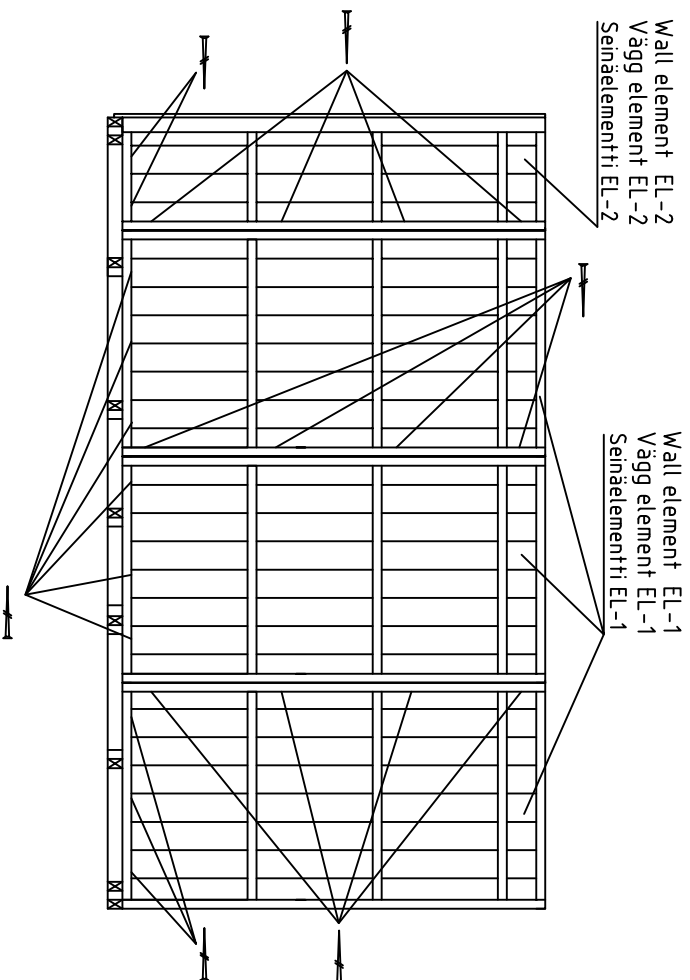

Fix wall element EL-2 and EL-1 (3pcs) with screws

4.5x70 into floorbeam

Fixera vägg element EL-2 och EL-1 (3st) med skruvar

4.5x70 i golvbjälke

Kiinnitä seinäelementti EL-2 ja EL-1 (3kpl) ruuveilla

4.5x70 lattiapalkkin

Fix wall elements EL-1b and EL-2 with screws 4.5x70 together

Fixera vägg element EL-1b och EL-2 med skruvar 4.5x70 tillsammans

Kiinnitä seinäelementit EL-1b ja EL-2 yhteen ruuveilla 4.5x70

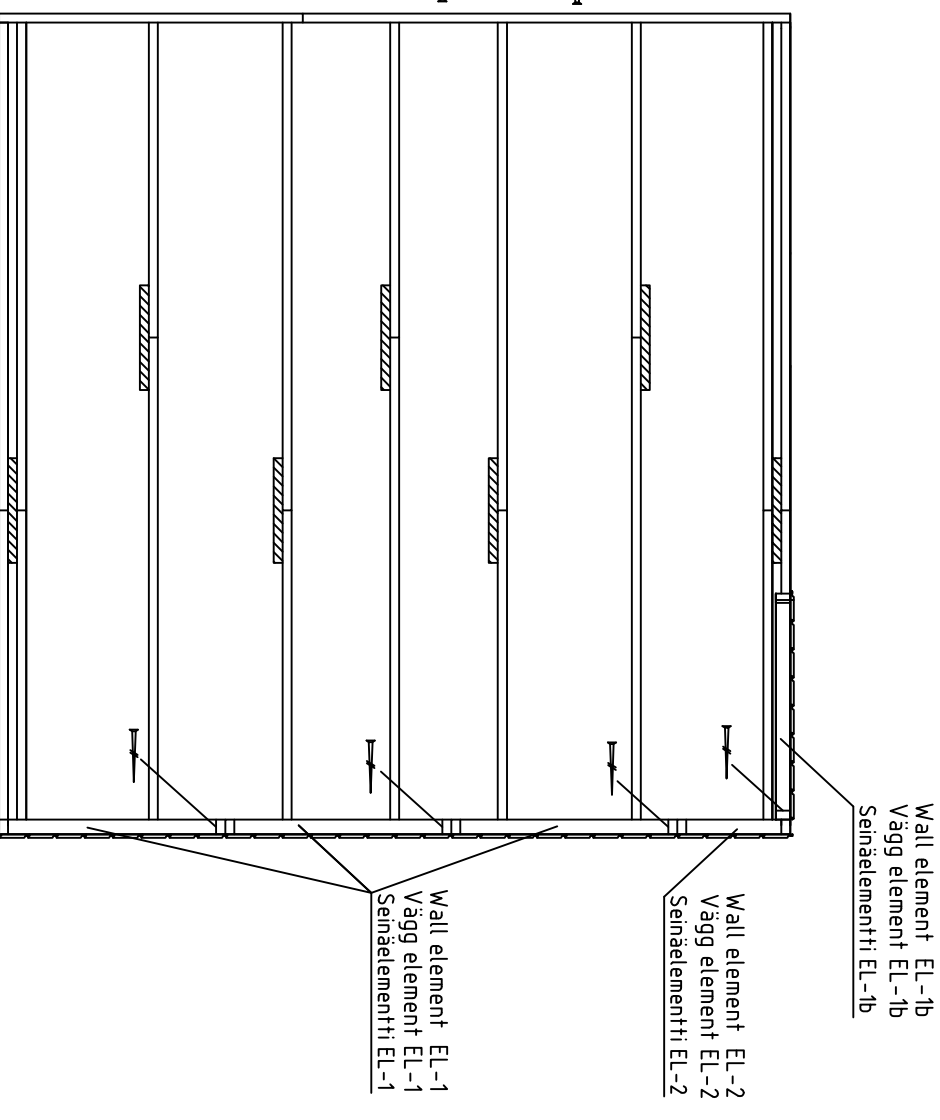

Wall element EL-1
Vägg element EL-1
Seinäelementti EL-1

Wall element EL-2
Vägg element EL-2
Seinäelementti EL-2

Wall element EL-1b
Vägg element EL-1b
Seinäelementti EL-1b

 Polhus		House	FE3838-16 Göte	Sheet	5
Drawer	K.K.	Drawing		Scale	1:35
		Material		Date	26.01.2016
		File	FE3838-16 Göte.dwg		

Installation of back wall – montering av vägg baksida – takaseinä asennus

View from inside – Från insidan – Näkymä sisästä

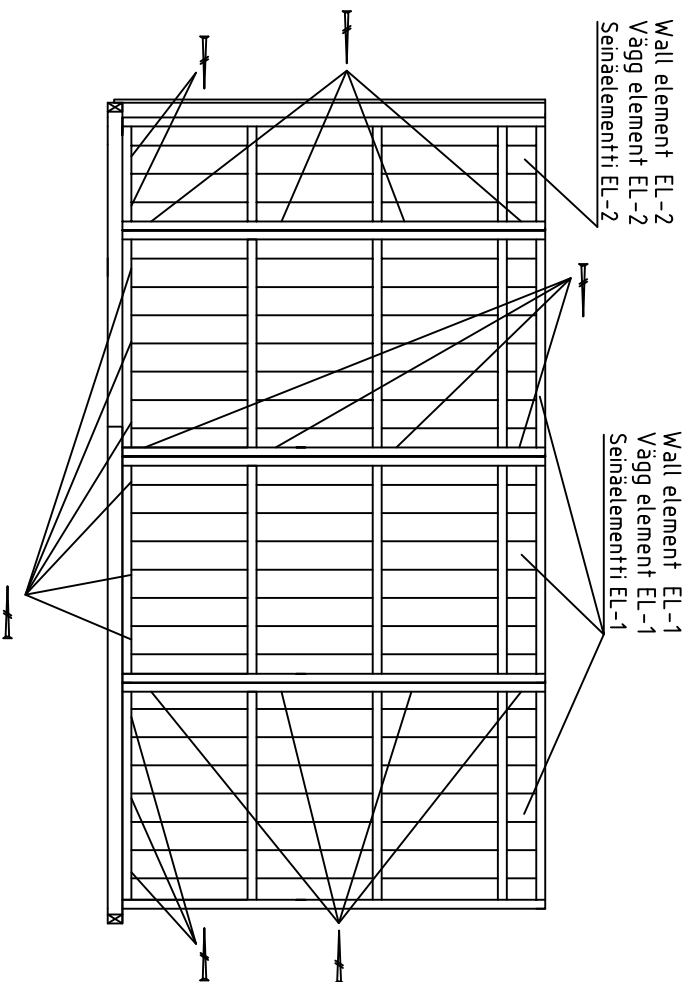

Fix wall element EL-2 and EL-1 (3pcs) with screws

4.5x70 into floorbeam

Fixera vägg element EL-2 och EL-1 (3st) med skruvar

4.5x70 i golvbjälke

Kiinnitä seinäelementti EL-2 ja EL-1 (3kpl) ruuveilla

4.5x70 lattiapalkkin

Fix wall elements EL-1 and EL-2 with screws 4.5x70 together

Fixera vägg element EL-1 och EL-2 med skruvar 4.5x70 tillsammans

Kiinnitä seinäelementit EL-1 ja EL-2 yhteen ruuveilla 4.5x70

Wall element EL-1b
Vägg element EL-1b
Seinäelementti EL-1b

Wall element EL-2
Vägg element EL-2
Seinäelementti EL-2

Wall element EL-1
Vägg element EL-1
Seinäelementti EL-1

Wall element EL-2
Vägg element EL-2
Seinäelementti EL-2

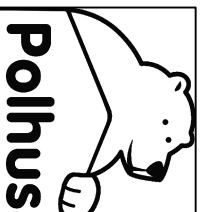
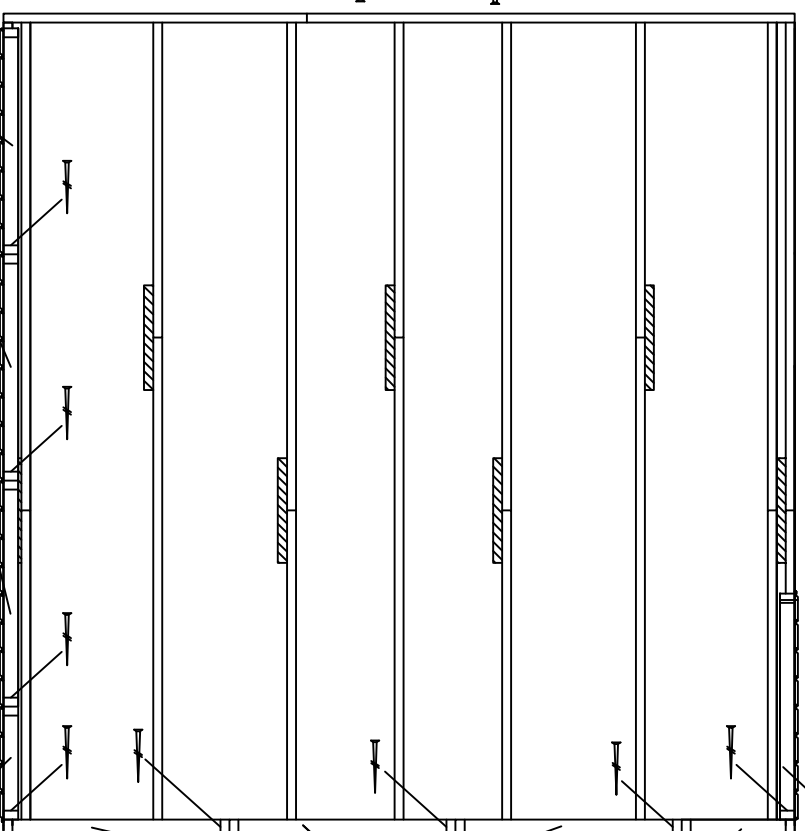

House	FE3838-16 Göte	Sheet	6
Drawing		Scale	1:35
Material		Date	26.01.2016
Drawer	K.K.	File	FE3838-16 Göte.dwg

Installation of right sidewall – montering av höger sidovägg – oikea sivuseinä asennus

View from inside – Från insidan – Näkymä sisästä

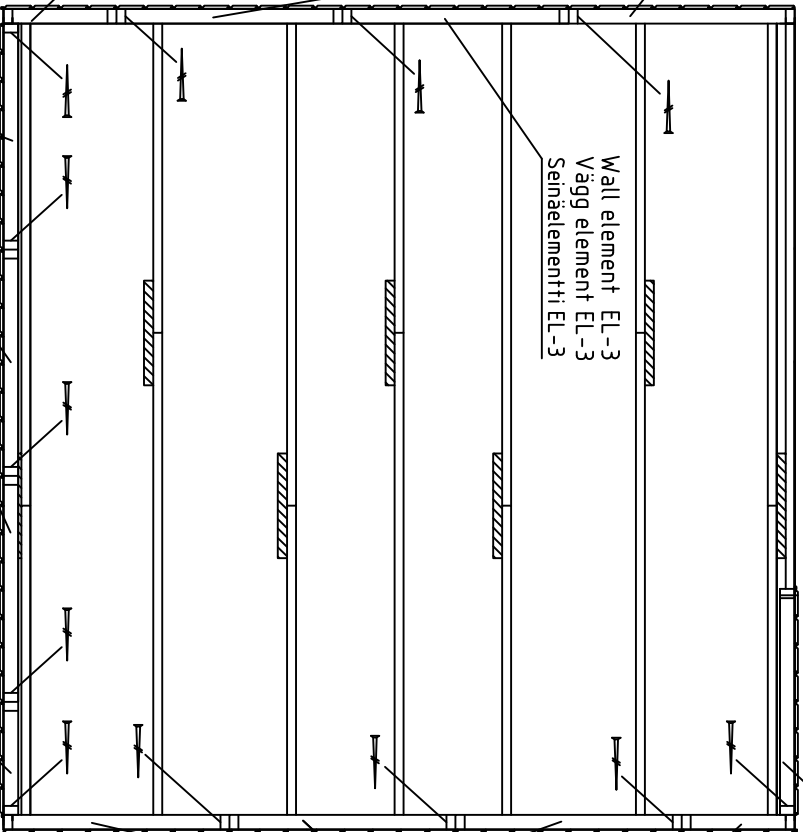
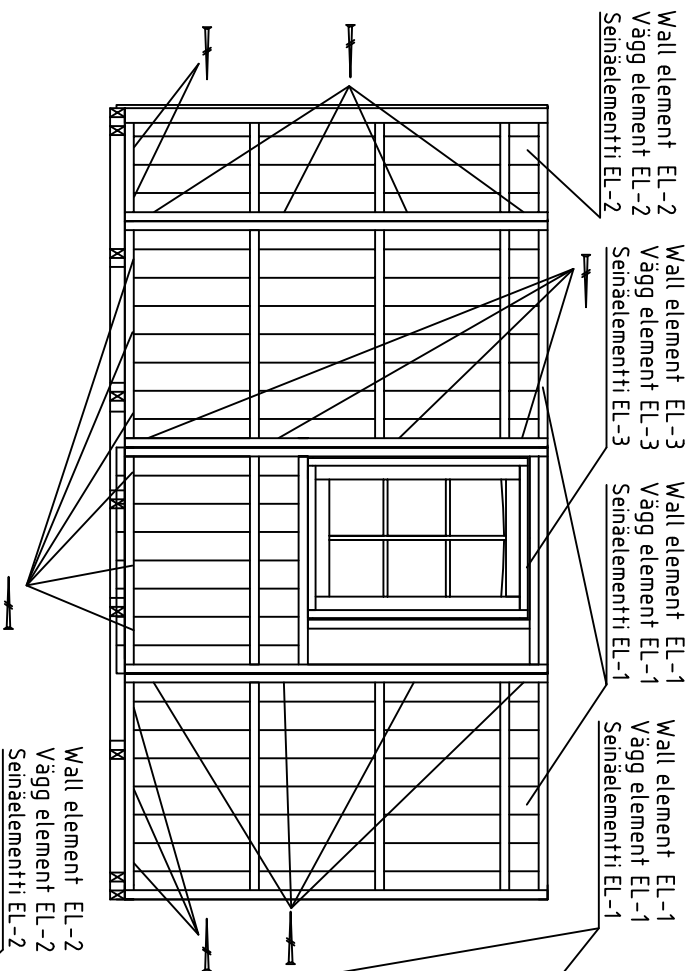

- Wall element EL-2
Vägg element EL-2
Seinäelementti EL-2
- Wall element EL-3
Vägg element EL-3
Seinäelementti EL-3
- Wall element EL-1
Vägg element EL-1
Seinäelementti EL-1
- Wall element EL-1
Vägg element EL-1
Seinäelementti EL-1
- Wall element EL-2
Vägg element EL-2
Seinäelementti EL-2
- Wall element EL-2, EL-3 and EL-1 (2pcs) with screws
4,5x70 into floorbeam
- Fixera vägg element EL-2, EL-3 and EL-1 (2pcs) med skruvar
4,5x70 i golvbjälke
- Kiinnitä seinäelementti EL-2, EL-3 and EL-1 (2pcs) ruuvilla
4,5x70 lattipalkkin
- Fix wall elements EL-2, EL-2 and EL-3 with screws 4,5x70 together
- Fixera vägg element EL-2, EL-2 and EL-3 med skruvar 4,5x70 tillsammans
- Kiinnitä seinäelementit EL-2, EL-2 and EL-3 yhteen ruuvilla 4,5x70

Wall element EL-1b
Vägg element EL-1b
Seinäelementti EL-1b

Wall element EL-2
Vägg element EL-2
Seinäelementti EL-2

Wall element EL-1
Vägg element EL-1
Seinäelementti EL-1

Wall element EL-2
Vägg element EL-2
Seinäelementti EL-2

Wall element EL-1
Vägg element EL-1
Seinäelementti EL-1

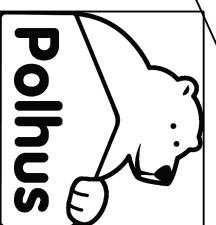

House	FE3838-16 Göte	Sheet	7
Drawing		Scale	1:35
Material		Date	26.01.2016
Drawer	K.K	File	FE3838-16 Göte.dwg

Installation of wall element EL-1a – montering av vägg element EL-1a – seinäelementin EL-1a asennus (Front wall – vägg framsida – etuseinä)

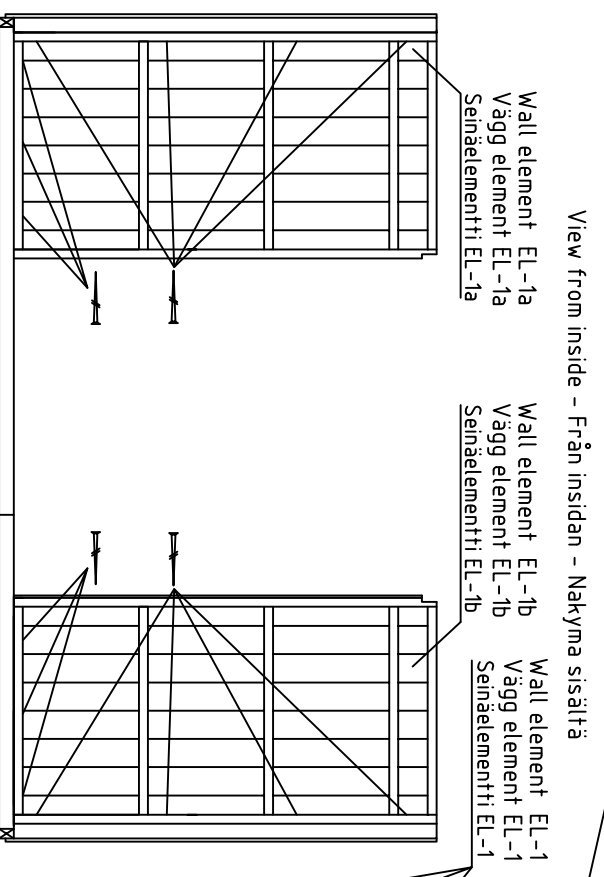

Filling board FIL2
Fyllnadsbräde 16x70x2060
Täyttölauta

Wall element EL-1a
Vägg element EL-1a
Seinäelementti EL-1a

Wall element EL-1b
Vägg element EL-1b
Seinäelementti EL-1b

Wall element EL-2
Vägg element EL-2
Seinäelementti EL-2

Wall element EL-1
Vägg element EL-1
Seinäelementti EL-1

Wall element EL-2
Vägg element EL-2
Seinäelementti EL-2

Filling board FIL1
Fyllnadsbräde 16x80x2060
Täyttölauta

Wall element EL-1
Vägg element EL-1
Seinäelementti EL-1

Wall element EL-2
Vägg element EL-2
Seinäelementti EL-2

- Fix wall element EL-1a with screws 4.5x70 into floorbeam
- Fixera vägg element EL-1a med skruvar 4.5x70 i golvbjälke
- Kiinnitä seinäelementti EL-1a ruuveilla 4.5x70 lattipalkkiin
- Fix wall elements EL-1a and EL-1 (side) with screws 4.5x70 together
- Fixera vägg element EL-1a och EL-1 (sidovägg) med skruvar 4.5x70 tillsammans
- Kiinnitä seinäelementit EL-1a ja EL-1 (sivuseinä) yhteen ruuveilla 4.5x70

	House	FE3838-16 Göte	Sheet	8
	Drawing		Scale	1:35
Material		Date	26.01.2016	
Drawer	K.K.		File	FE3838-16 Göte.dwg

Installation of sidewall connecting beams - montering av bjälkar för sidovägg sammanslagning - sivuseinä yhdistämisspalkit asennus

Screws 4.5x70 4pcs
 Skruvar 4.5x70 4st
 Ruuvit 4.5x70 4kpl

Screws 4.5x70 4pcs
 Skruvar 4.5x70 4st
 Ruuvit 4.5x70 4kpl

Screws 4.5x70 4pcs
 Skruvar 4.5x70 4st
 Ruuvit 4.5x70 4kpl

Screws 4.5x70 4pcs
 Skruvar 4.5x70 4st
 Ruuvit 4.5x70 4kpl

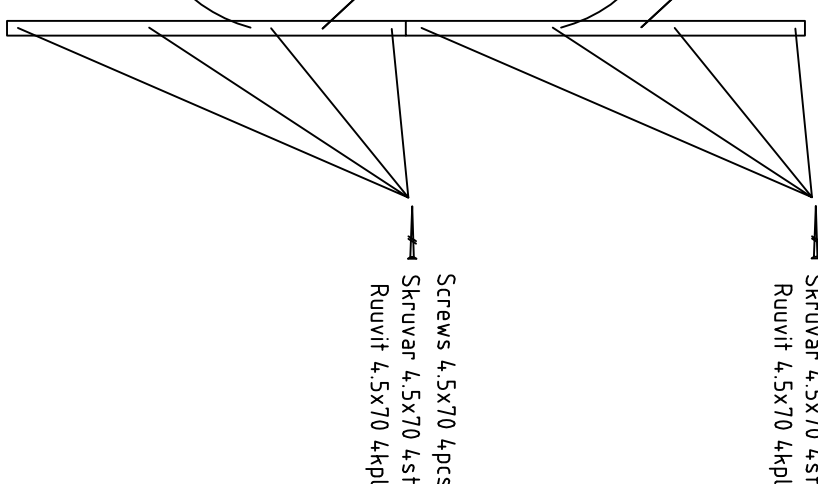
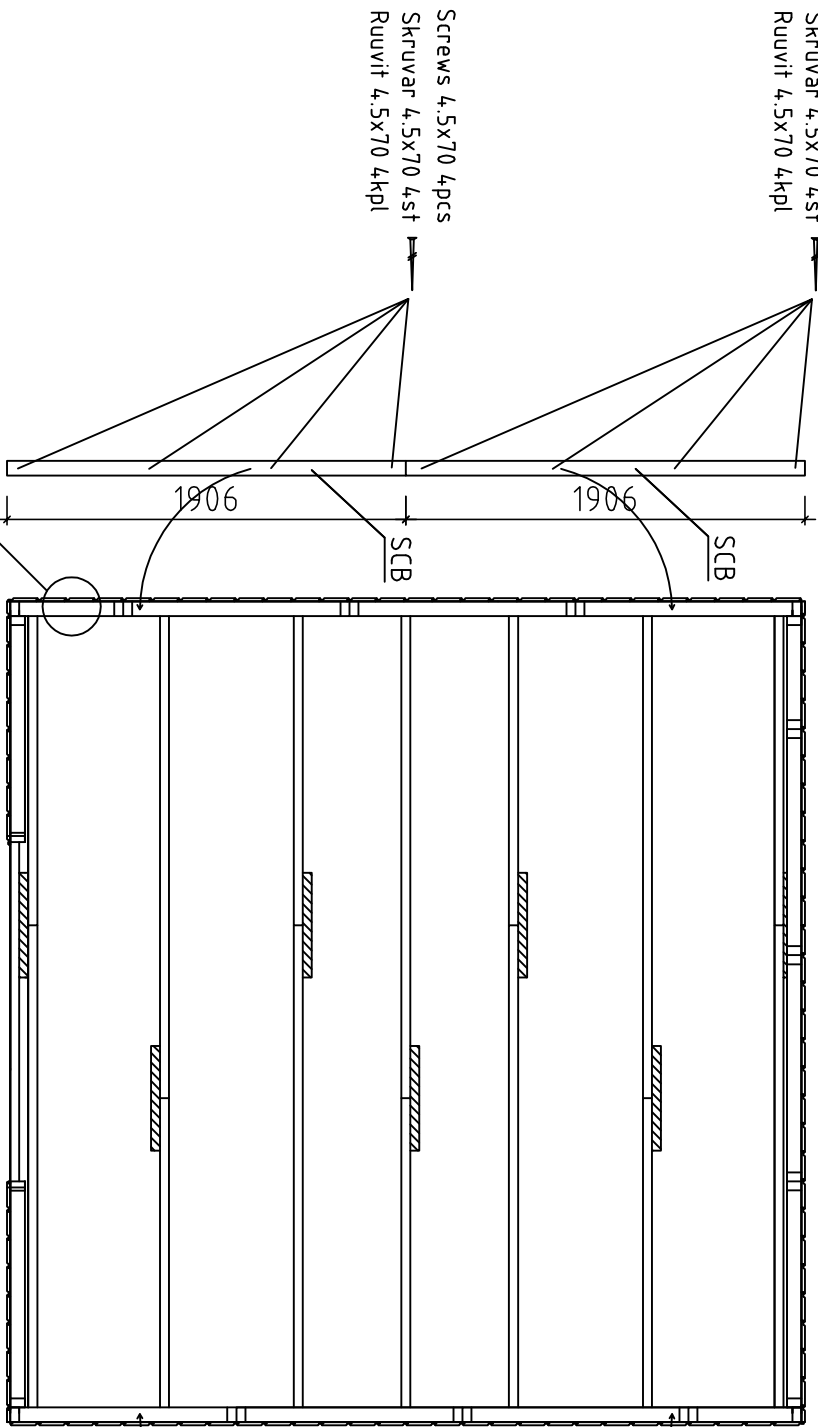

Screws 4.5x70
 Skruvar 4.5x70
 Ruuvit 4.5x70

Detail A

Detail A

SCB

Sidewall-sidovägg-sivuseinä

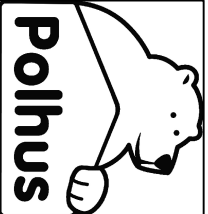
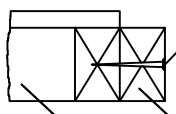

House	FE3838-16 Göte	Sheet	9
Drawing		Scale	1:35
Material		Date	26.01.2016
Drawer	K.K.	File	FE3838-16 Göte.dwg

Installation of wall element EL-4 and EL-5 – montering av vägg element EL-4 och EL-5 – seinäelementin EL-4 ja EL-5 asennus
(Front wall – vägg framsida – etuseinä)

View from inside – Från insidan – Näkymä sisältä

Connect with metal plate 60x160 +screws 5.0x40
Skarvas med metall platta 60x160+skravar 5.0x40
Liitetään metallilevyllä 60x160+ruuvit 5.0x40

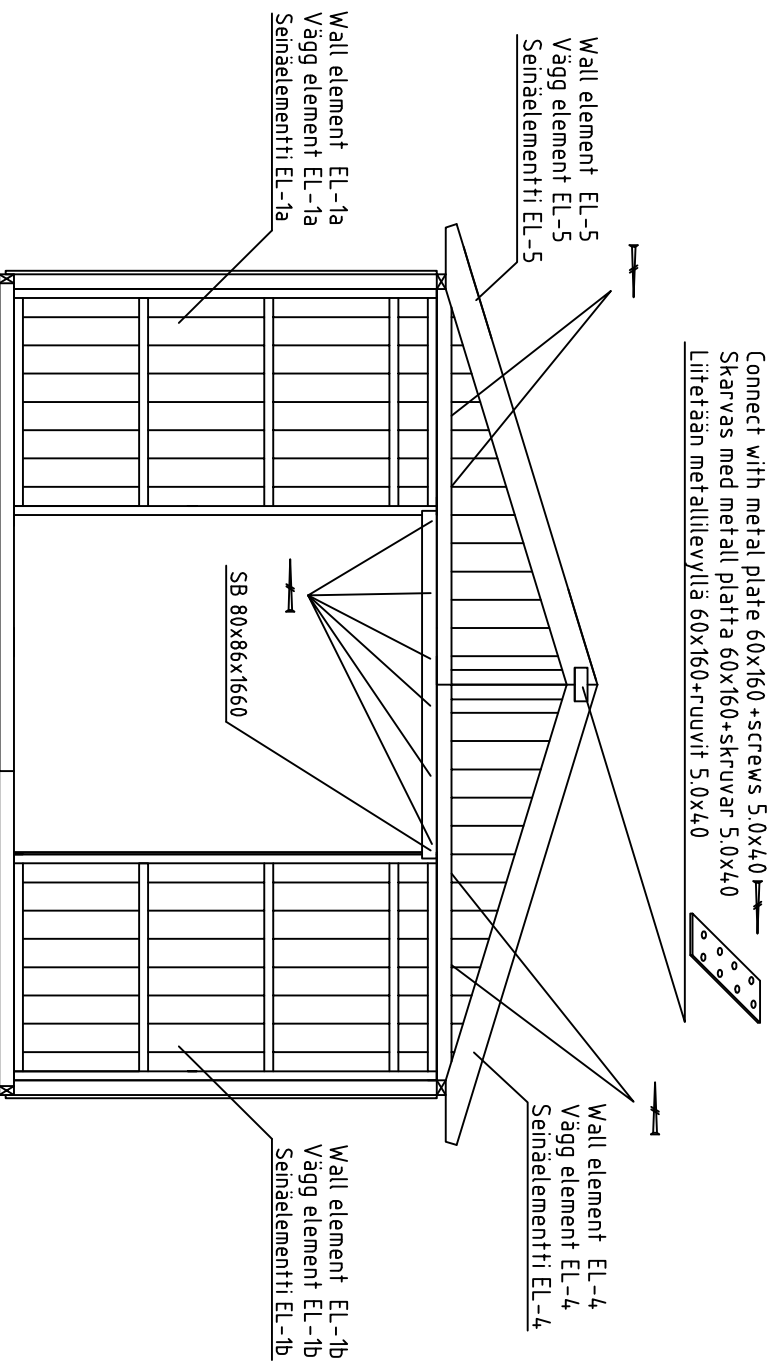

Fix wall elements EL-5 and EL-1a with screws 5.0x120 together

Fixera vägg elementat EL-5 och EL-1a med skruvar 5.0x120 tillsammans

Kiinnitä seinäelementit EL-5 ja EL-1a yhteen ruuveilla 5.0x120

Fix supporting beam SB with wall elements EL-4 and EL-5 (screws 5.0x120) together

Fixera stödbjälke SB med vägg elementat EL-4 och EL-5 (skruvar 5.0x120) tillsammans

Kiinnitä tukipalkki SB yhteen seinäelementit EL-4 ja EL-5 ruuveilla 5.0x120

Fix wall elements EL-4 and EL-1b with screws 5.0x120 together

Fixera vägg elementat EL-4 och EL-1b med skruvar 5.0x120 tillsammans

Kiinnitä seinäelementit EL-4 ja EL-1b yhteen ruuveilla 5.0x120

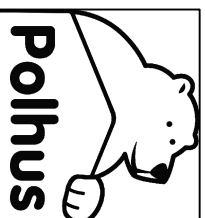

House	FE3838-16 Göte	Sheet	10
Drawing		Scale	1:35
Material		Date	26.01.2016
Drawer	K.K.	File	FE3838-16 Göte.dwg

Installation of wall element EL-4 and EL-5 - monterering av vägg element EL-4 och EL-5 -seinälementin EL-4 ja EL-5 asennus
(Back wall-vägg baksida-takaseinä)

View from inside - Från insidan - Näkymä sisältä

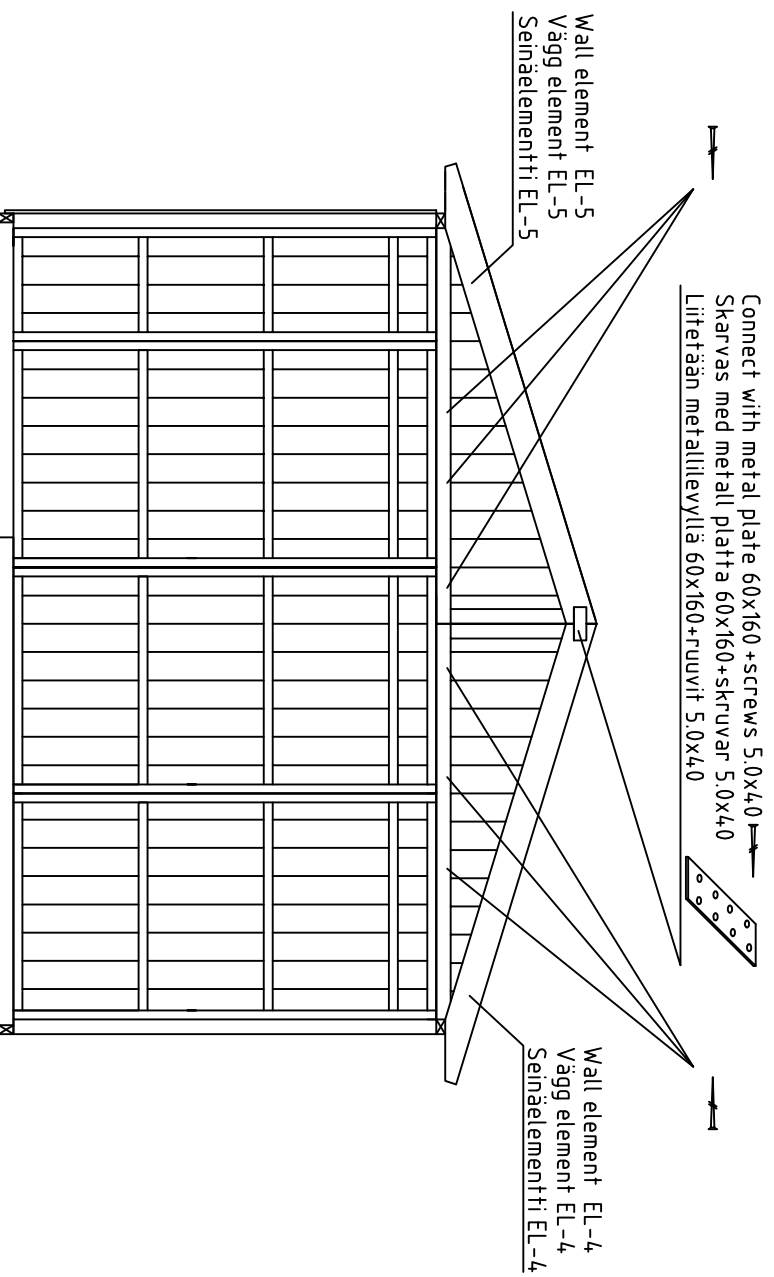

Fix wall element EL-5 with back wall elements with screws 5.0x120 together

Fixera vägg element EL-5 med elementat vägg baksida med skruvar 5.0x120 tillsammans

Kiinnitä seinäelementti EL-5 yhteen takaseinän elementit ruuveilla 5.0x120

Fix wall element EL-4 with back wall elements with screws 5.0x120 together

Fixera vägg element EL-4 med elementat vägg baksida med skruvar 5.0x120 tillsammans

Kiinnitä seinäelementti EL-4 yhteen takaseinän elementit ruuveilla 5.0x120

 Polhus	House	FE3838-16 Göte	Sheet	11
	Drawing		Scale	1:35
	Material		Date	26.01.2016
Drawer	K.K.		File	FE3838-16 Göte.dwg

Ferms - Takläggning - Kattoparrut

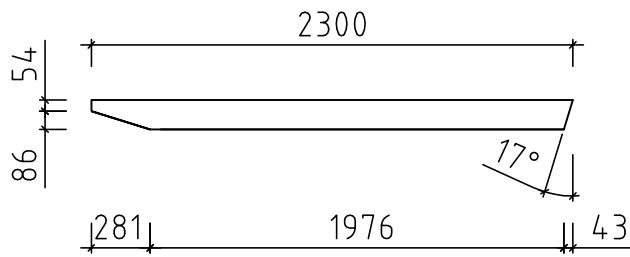

Rafter-kattopalki-takbjälkar 43x140x2300 6pcs-st-kpl

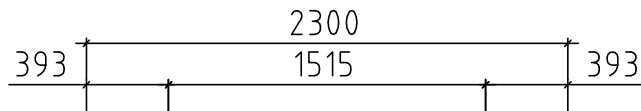

Tie beam-kattopalki-takbjälkar 28x120x2300 6pcs-st-kpl

Connect with metal plate 60x160
+screws 5.0x40 12pcs

on both sides of the ferm

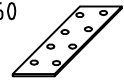

Skarvas med metall platta 60x160+skruvar 5.0x40
båda sidor takläggning

Liitetään metallilevyllä 60x160+ruuvit 5.0x40
molemmin puolin kattoparru

Ferms 3pcs
Takläggning 3st
Kattoparrut 3kpl

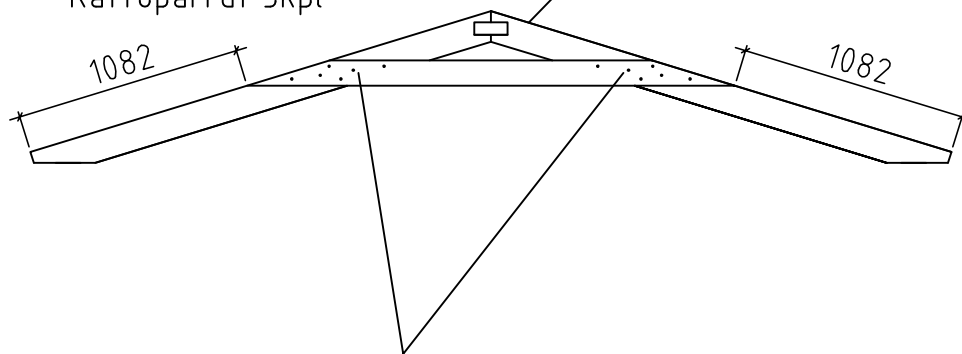

Connect with nails 4x100 (6+6)
on both sides of the ferm

Skarvas med spikar 4x100 (6+6)
båda sidor takläggning

Liitetään naulalla 4x100 (6+6)
molemmin puolin kattoparru

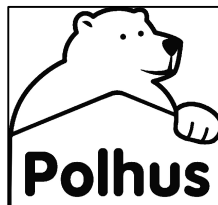

House FE3838-16 Göte

Sheet 12

Drawing

Scale 1:35

Material

Date 26.01.2016

Drawer

K.K.

File

FE3838-16 Göte.dwg

Ferm install-installera takläggning-kattoparru asennus

Connect with steel corner 90x90x65+screws 4.5x4.5 8pcs
 Skarvas med metallvinkel 90x90x65+skruvar 4.5x4.5 8st
 Littetään kulmarautaan 90x90x65+ruuvit 4.5x4.5 8kpl

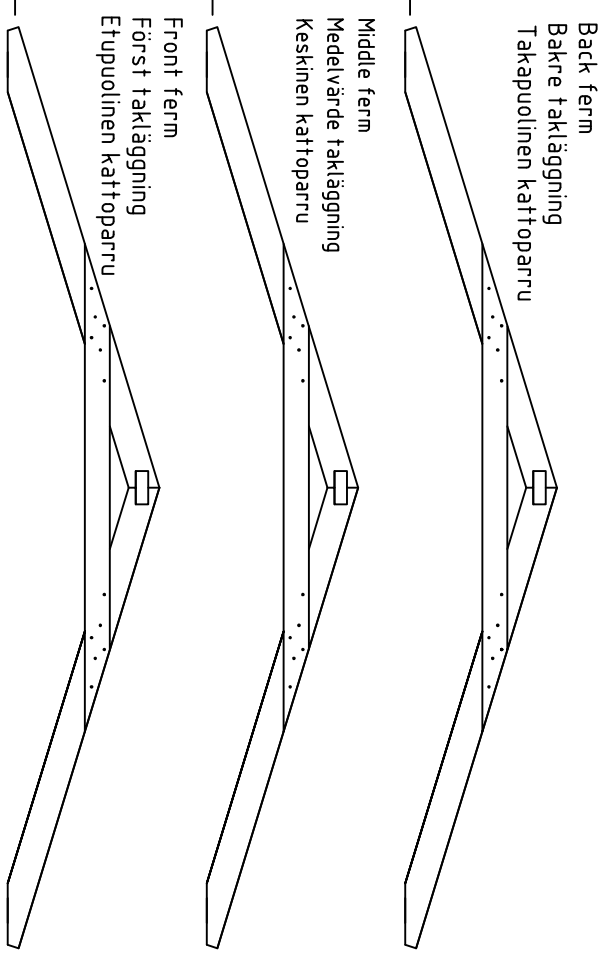
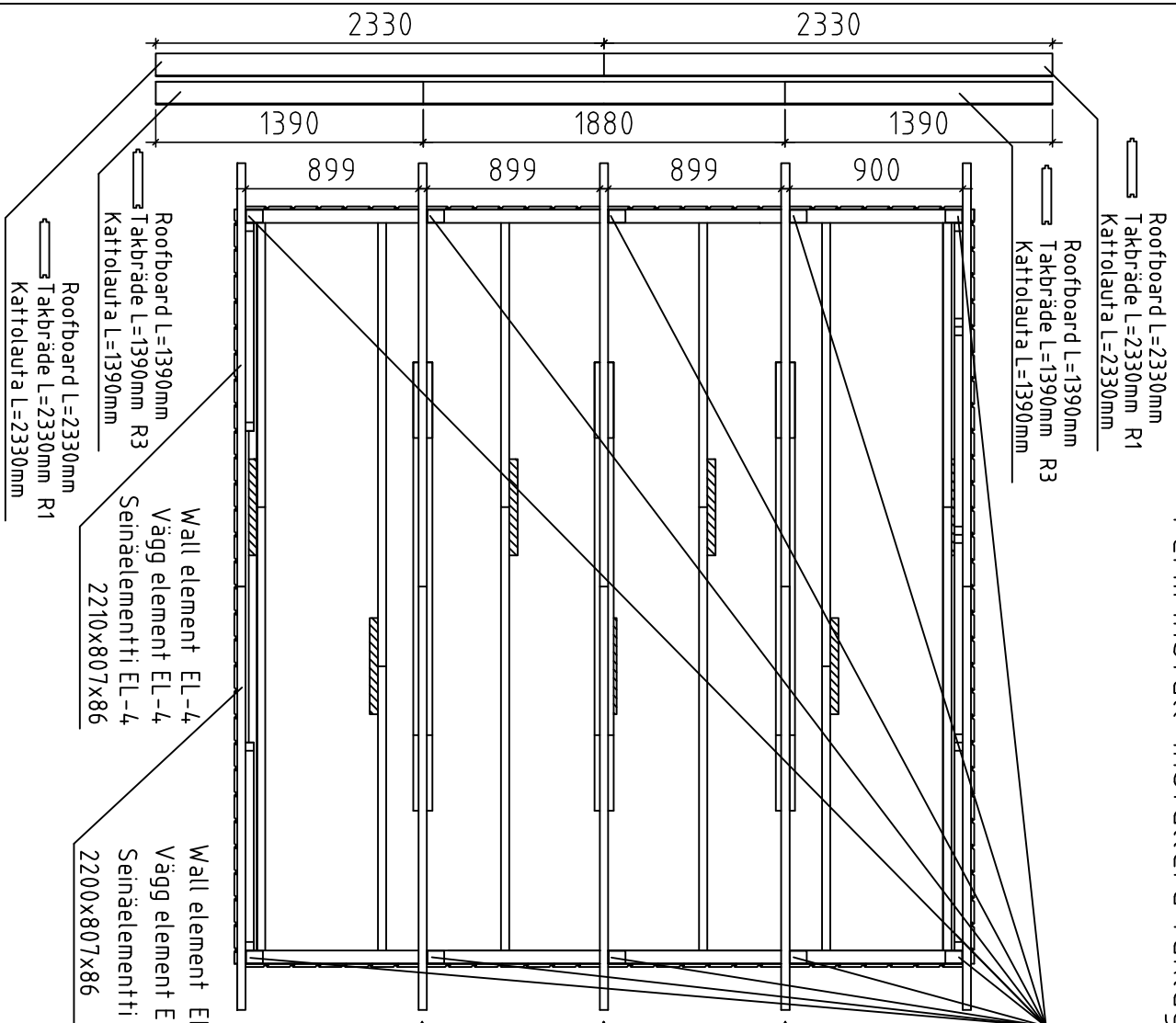

NB!!! Change the roofboard positions after every row
 NB!!! Skarva tak bräderna olika efter varje rad
 NB!!! Muuta kattolautojen sijaintia jokaisen rivin jälkeen

House	FE3838-16 Göte	Sheet	13
Drawing		Scale	1:35
Material		Date	26.01.2016
Drawer	K.K.	File	FE3838-16 Göte.dwg

Doubledoor install-Dubbeldörren sammanslagning-Tuplaoven kokoonpano

Doubledoor frame install-Dubbeldörren ramar sammanslagning-Tuplaoven karmi kokoonpano

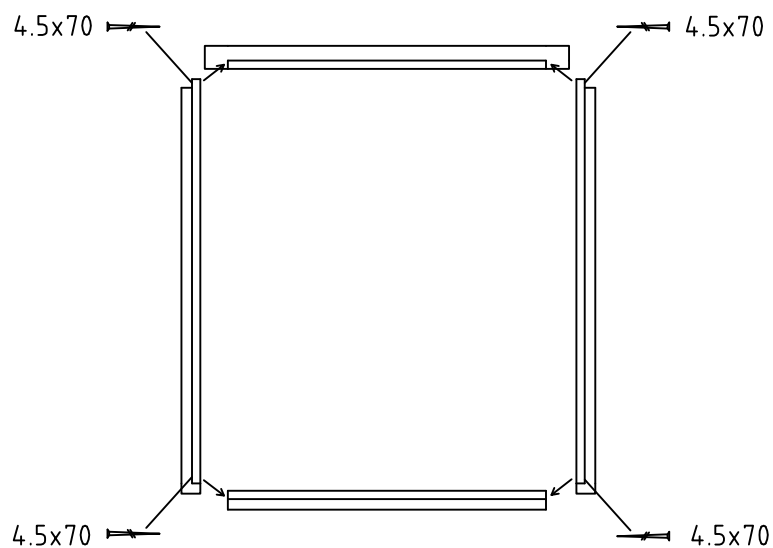

Fix door frame with screws 4.5x70 together

Fixera dörr ramar med skruvar 4.5x70 tillsammans

Kiinnitä oven karmi yhteen ruuveilla 4.5x70

Doubledoor hinge install-Dubbeldörren gångjärn installera-Tuplaoven sarana asennus

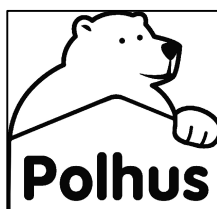
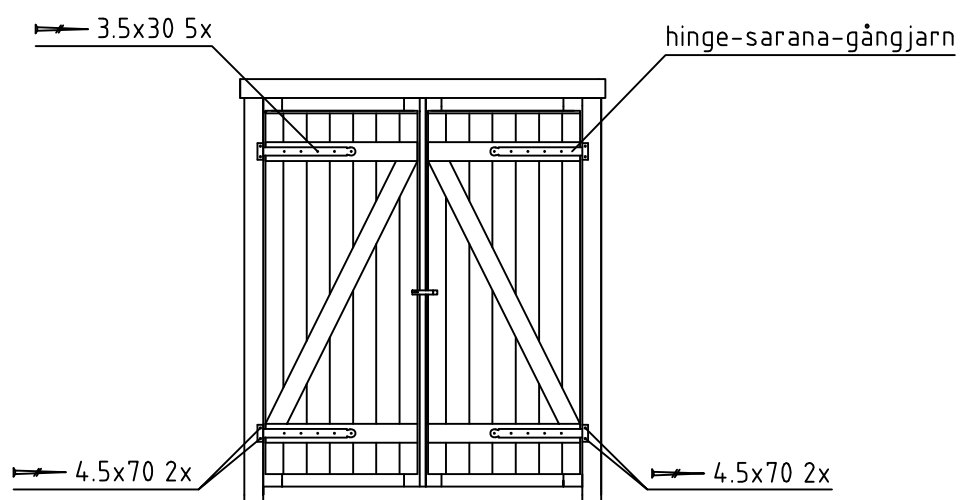

House	FE3838-16 Göte	Sheet	14
Drawing		Scale	1:35
Material		Date	26.01.2016
Drawer	K.K.	File	FE3838-16 Göte.dwg



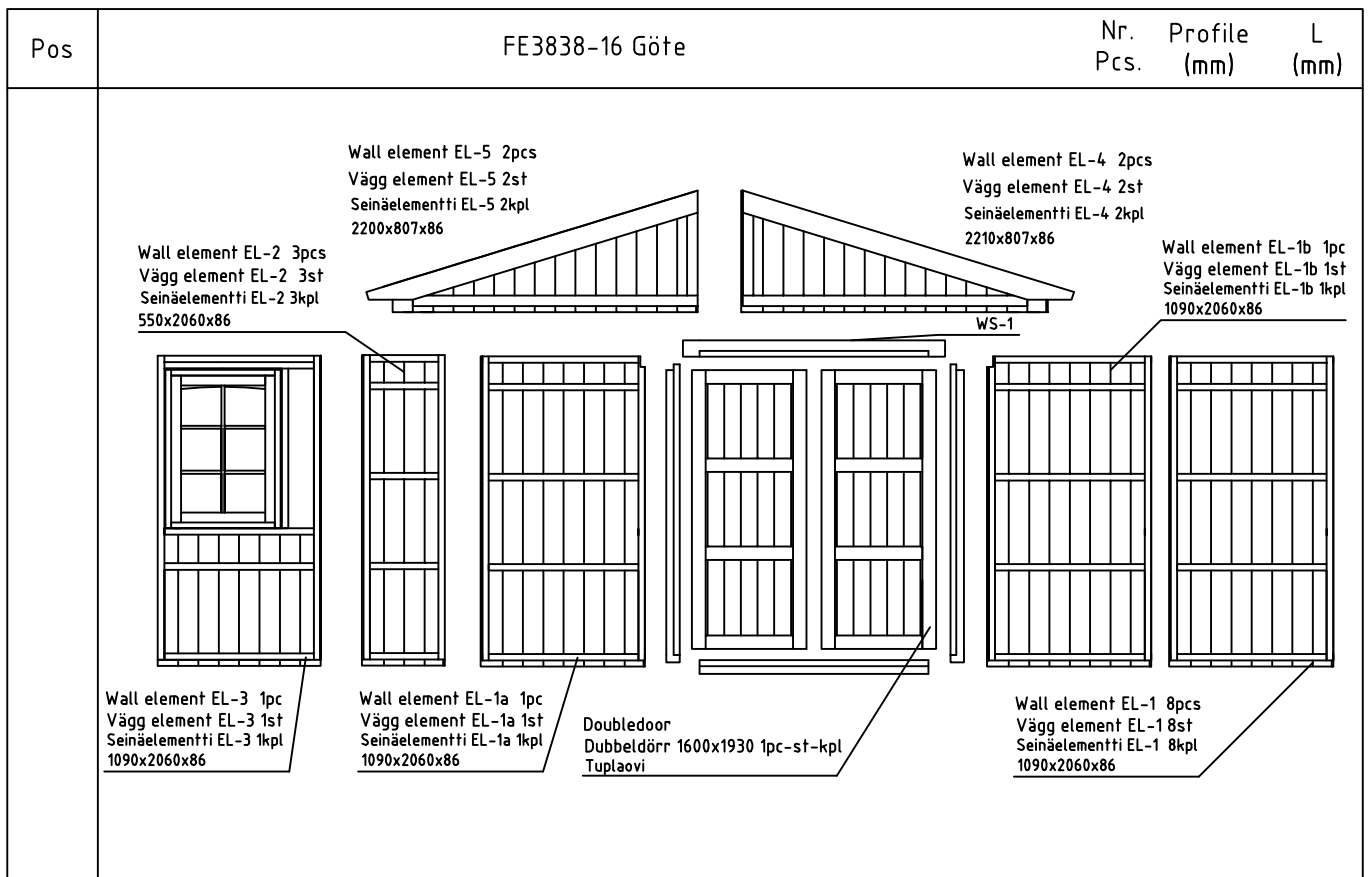







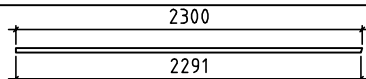







2 PAKKI L<2.35m

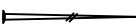

Pos	Description	Profile	Nr. Pcs.	Profile (mm)	L (mm)
RA	RAFTER - KATTOPALKI - TAKBJÄLKAR		6	43x140	2300
TB	TIE BEAM - KATTOPALKI - TAKBJÄLKAR		6	28x120	2300
FB1	FLOORBEAM - LATTIAPALKI - GOLVBJÄLKAR		11	45x90	2330
FB2	FLOORBEAM - LATTIAPALKI - GOLVBJÄLKAR		2	45x90	1450
FB3	FLOORBEAM - LATTIAPALKI - GOLVBJÄLKAR		9	45x90	1500
FB4	FLOORBEAM CONNECTING BEAM - LATTIAPALKI YHDISTAMISPALKIT BRÄDE FÖR GOLVBJÄLKAR SAMMANSLAGNING		7	45x90	500
SCB	SIDEWALL CONNECTING BEAM - SIVUSEINÄ YHDISTAMISPALKIT BJÄLKAR FÖR SIDOVÄGG SAMMANSLAGNING		4	45x70	1906
SB	SUPPORTING BEAM - TUKIPALKI-STÖDBJÄLKE		1 1	86x45 86x35	1660 1660
F1	FLOORBOARD - LATTIALAUTA - GOLVBRÄDE		34 43	19x114 19x88	2330 2330
F2	FLOORBOARD - LATTIALAUTA - GOLVBRÄDE		34 43	19x114 19x88	1300 1300
R1	ROOFBOARD - KATTOLAUTA - TAKBRÄDE		44 56	19x114 19x88	2330 2330
R2	ROOFBOARD - KATTOLAUTA - TAKBRÄDE		20 26	19x114 19x88	1880 1880
R3	ROOFBOARD - KATTOLAUTA - TAKBRÄDE		40 52	19x114 19x88	1390 1390
FF	FLOOR FILLET - LATTIALISTA - GOLVLIST		8	19x35	1900
GB	GABLE BOARD - KAAPLILAUTA - GAVELBRÄDA		4	19x120	2330

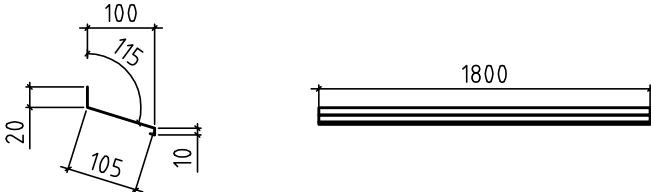

2 PAKKI L<2.35m

Pos	FE3838-16 Göte	Nr. Pcs.	Profile (mm)	L (mm)
RFF	ROOF FELT FILLET - KATON PÄÄTYLAUTA - BRÄDE OVANPÅ GAVELBRÄDE 	4	19x35	2330
GS	GABLE SLAT - KAAPELILISTA - VINDLIST 	4	30x40	2300
EB1	EAVE BOARD - RÄYSTÄSLAUTA - TAKFOTSBRÄDE 	4	19x120	2330
EB2		4	19x120	1906
EB3	EAVE BOARD - RÄYSTÄSLAUTA - TAKFOTSBRÄDE 	4	19x90	1906
CB1	CORNER BOARD - KULMANLAUTA - HÖRNBRÄDE 	4	19x90	2060
CB2		4	19x90	2040
FIL1	FILLING BOARD- TÄYTTÖLAUTA- FYLLNADSBRÄDE 	2	16x80	2060
FIL2	FILLING BOARD- TÄYTTÖLAUTA- FYLLNADSBRÄDE 	2	16x70	2060
	STEEL CORNER - KULMARAUTA - VINKELJÄRN 	10	90x90	65
	STEEL PLATE - METALLILEVY - METALLPLATTA 	8 4	2,5x60 2,5x60	160 120
	NAILS - NAULAT - SPIKAR  FERMS - KATTOPARRU - TAKLÄGGNING	72	4,0	100
	NAILS - NAULAT - SPIKAR  FLOORBOARD - LATTIALAUTA - GOLVBRÄDE	715	2,5	60
	NAILS - NAULAT - SPIKAR  ROOFBOARD - KATTOLAUTAT - TAKBRÄDE	32	2,0	40
	SCREW - RUUVIT - SKRUVAR  ELEMENT - ELEMENT - ELEMENTTI NR.3 & NR.4	25	5,0	120
	SCREW - RUUVIT - SKRUVAR  FLOORBEAMS - LATTIAPALKIT - GOLVBJÄLKAR	240	4,5	70
	SCREW - RUUVIT - SKRUVAR  ELEMENT CONNECTING - ELEMENTTI YHDISTAMIS	120	5,0	40
	SCREW - RUUVIT - SKRUVAR  STEEL PLATE - METALLILEVY - METALLPLATTA	280	4,5	45
	DOOR LATCH (CLOSER)-OVEN SALPA-DÖRR SPÄRREN 	1		
	DOOR HINGES-OVEN SARANAT-DÖRR GÅNGJÄRN 	4		
	WINDOW CROSSES - IKKUNARISTIKKO - SPRÖJS 	1		
	WINDOW HANDLE - IKKUNA KAHVA - FÖNSTER HANDTAG 	1		
WS-1	WATER SILL 	1		

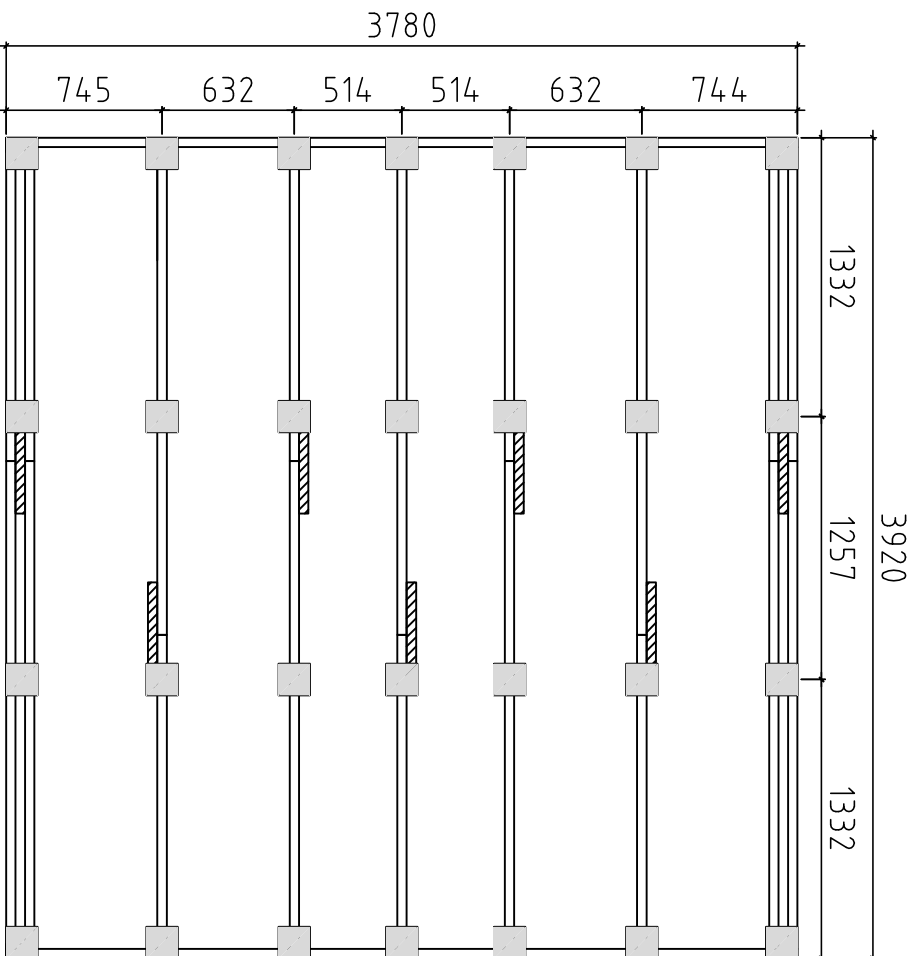

Detta är ett förslag för hur man kan placera plintarna (100-200 mm i diameter) för golvvägglaget. Golvväggarna är med i byggsatsen, men inte plintarna. Använder man exempelvis 500-600mm långa murblock så kan man halvera antalet punkter. Lägg fuktskyddande papp mellan betong och trä

Tämä on ehdotus siltä, miten (100-200 mm läpimittaiset) jalat voidaan sijoittaa alapohjaa varten. Lattiapaikit ovat rakennussarjassa, mutta jalat ei ole. Kun käytetään esimerkiksi 500-600 mm pitkiä harkkoja, voidaan pisteiden määrä puolittaa. Aseta betonin ja puun väliin kosteudelta suojaava paperi

A proposal for placing plinths (100-200 mm in diameter) for floor beams. Floor beams are provided in the kit but plinths are not included. For example, by using 500-600 mm long masonry units, one can reduce the number of points 50%. Place cardboard between the concrete and wood to protect from moisture

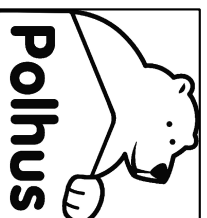

Polhus

House	FE3838-16 Göte	Sheet	17
Drawing	Plan	Scale	1:35
Material		Date	26.01.2016
Drawer	K.K.	File	FE3838-16 Göte.dwg