

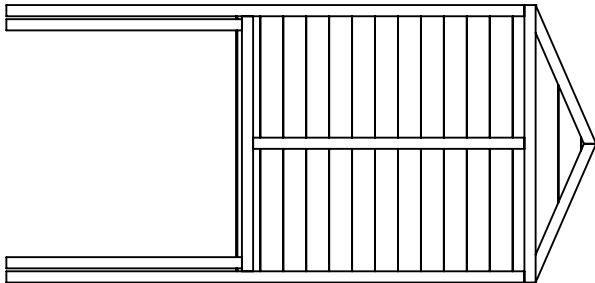

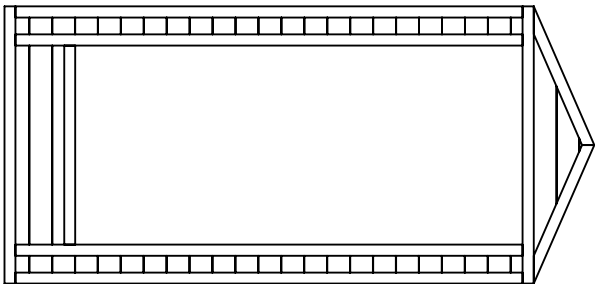
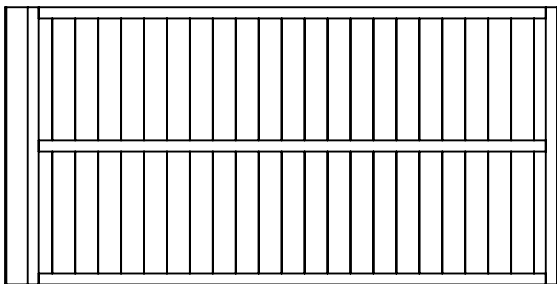
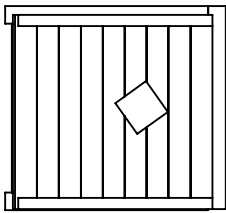
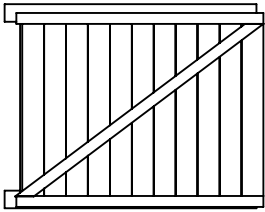
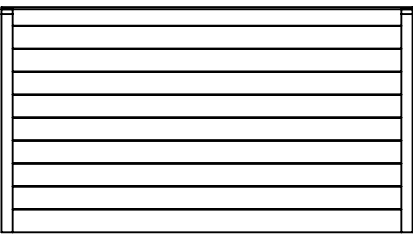
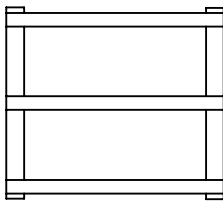
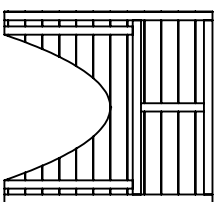
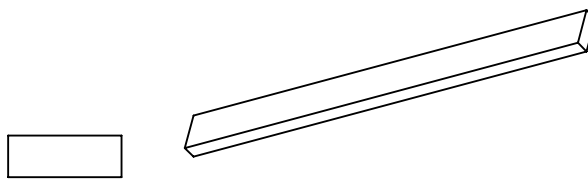

BW		2340*1100*63	1
FW		2340*1100*63	1
SW		2167*1100*63	2
D1		875*805*63	1
D2		1055*805*63	1
R		1630*893*63	2

F1		1150*1012*56	1
F2		1100*1010*113	1
1.1		44*120*1450	2
1.2		44*120*360	1
1.3		44*120*1010	1
2		44*120*1100	2
3		44*120*130	2
4		13*70*910	4
5		19*63*2150	4
6		28*95*1100	3

hinge

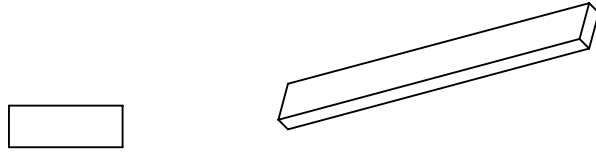
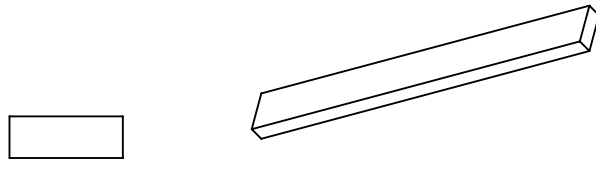

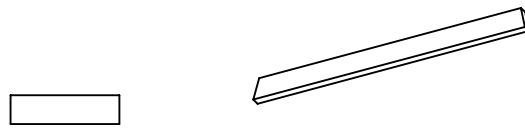
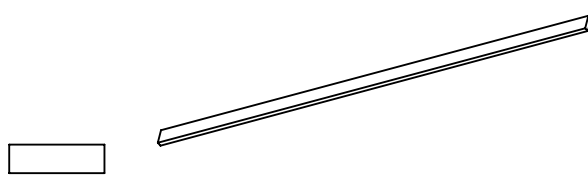
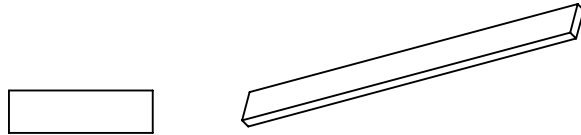
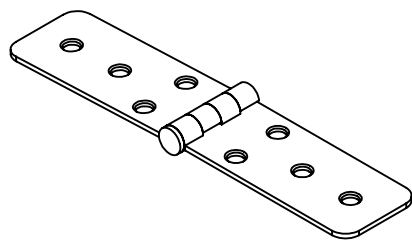
4

80mm screws

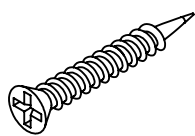

42

50mm screws

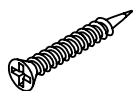

33

40mm screws



64

NB! drill the pilot holes for the screws

F1	1
1.1	2
1.2	1
1.3	1
80mm screws	6

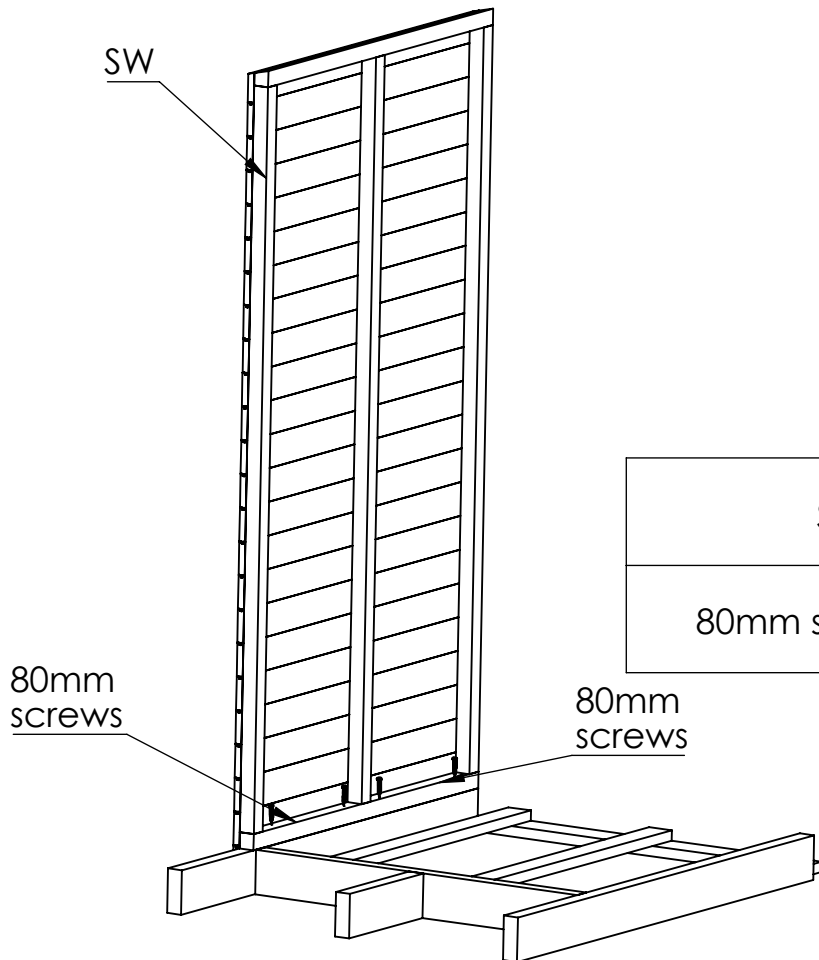
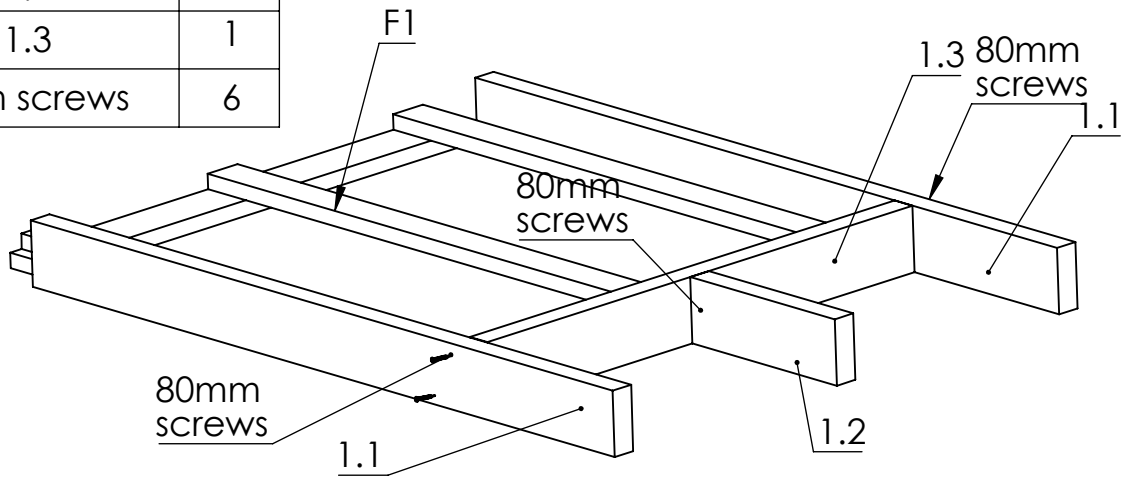

SW	1
80mm screws	4

NB! drill the pilot holes for the screws

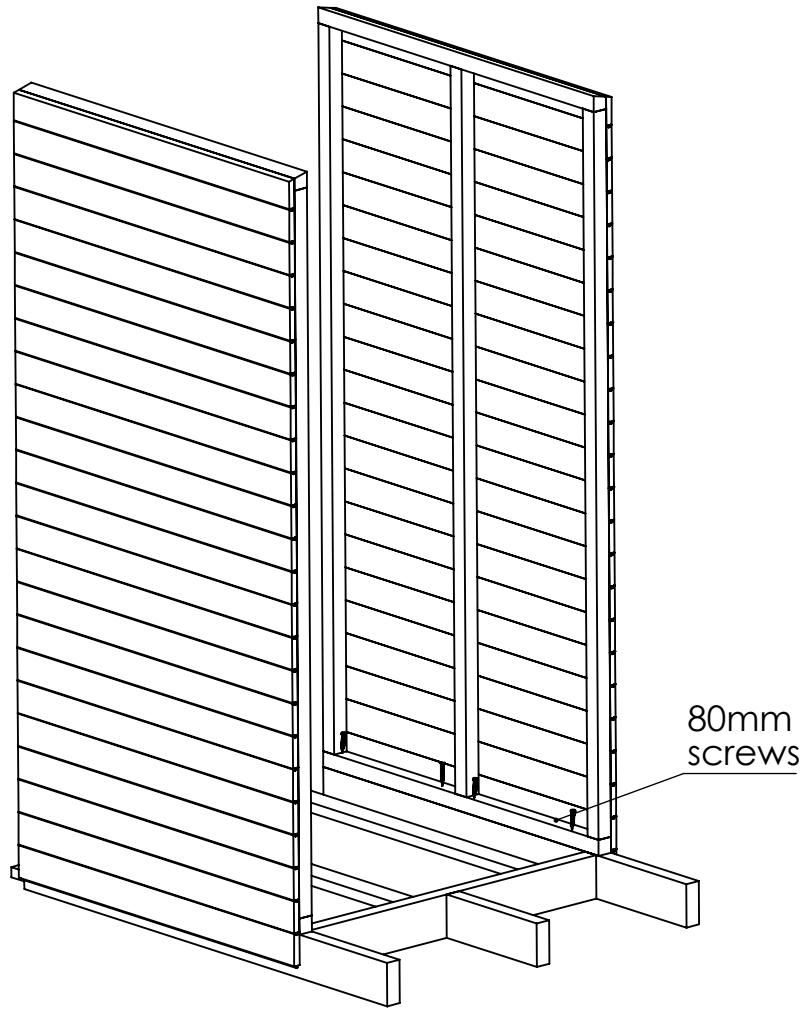

SW	1
80mm screws	4

2	2
80mm screws	8

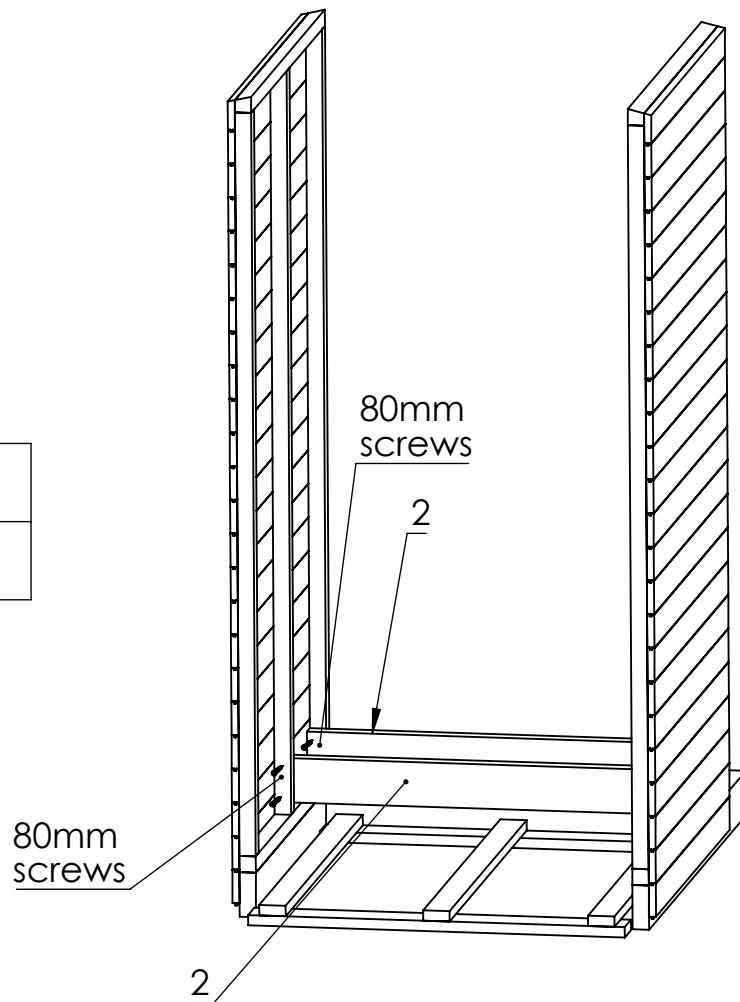

NB! Drill the pilot holes for the screws

3	2
80mm screws	4

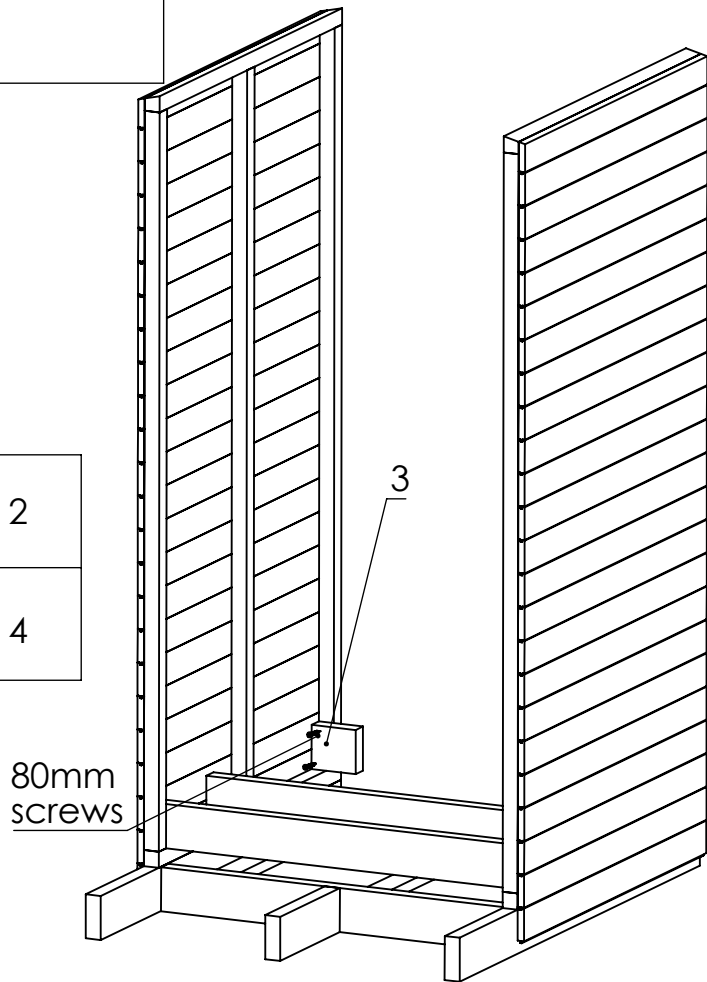

F2	1
----	---

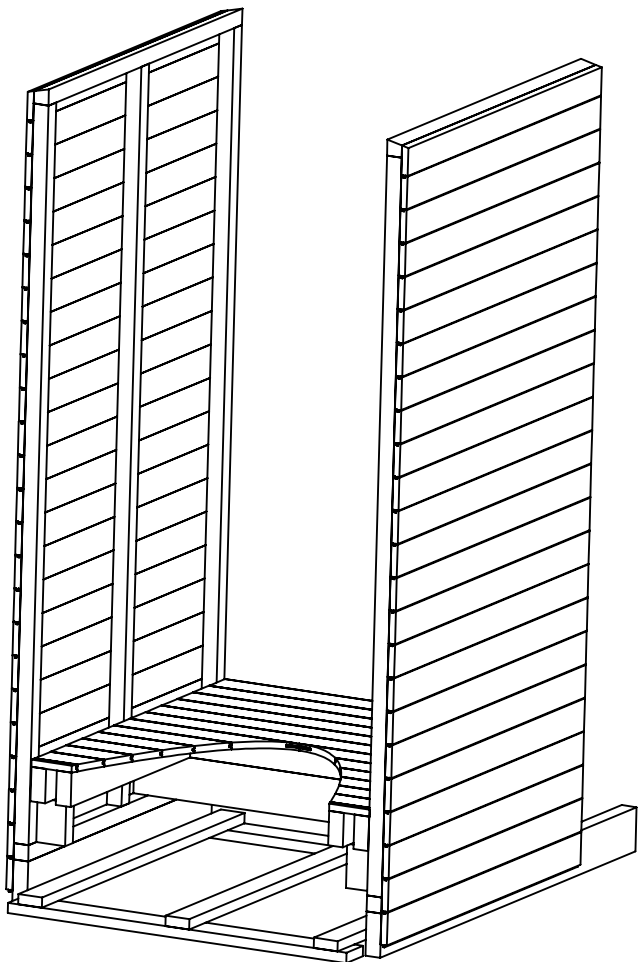

NB! Drill the pilot holes for the screws

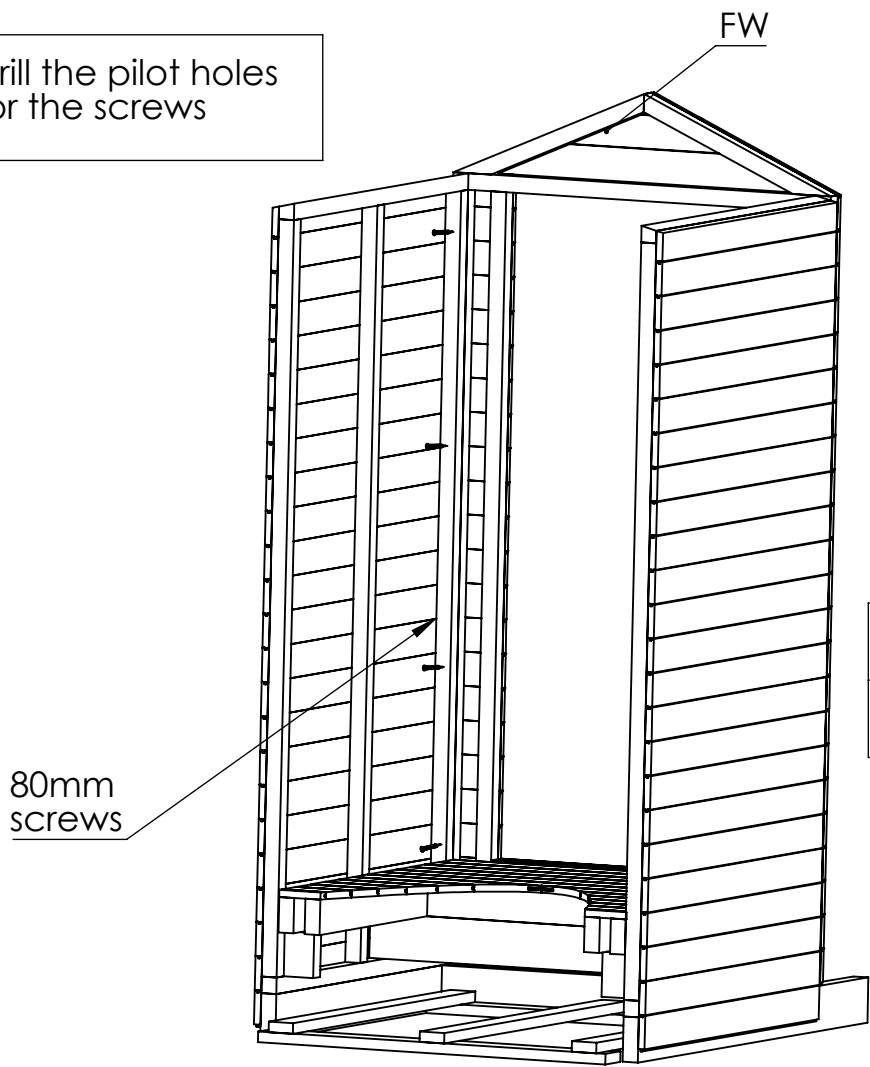

FW	1
80mm screws	8

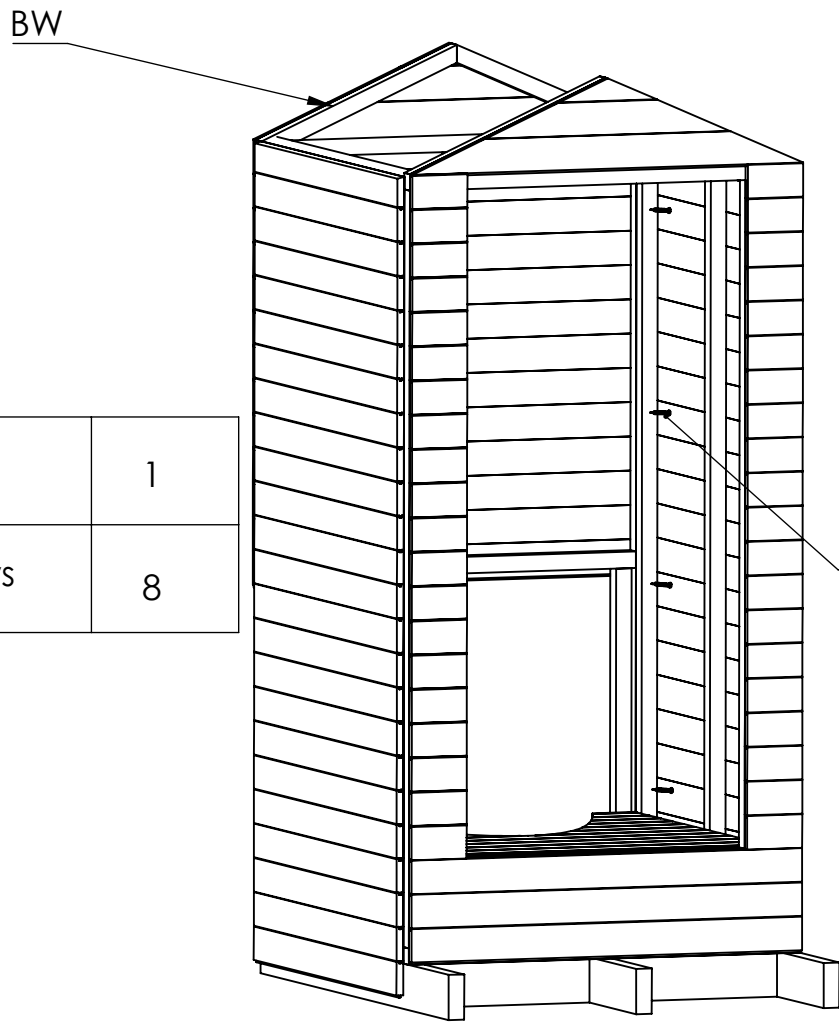

BW	1
80mm screws	8

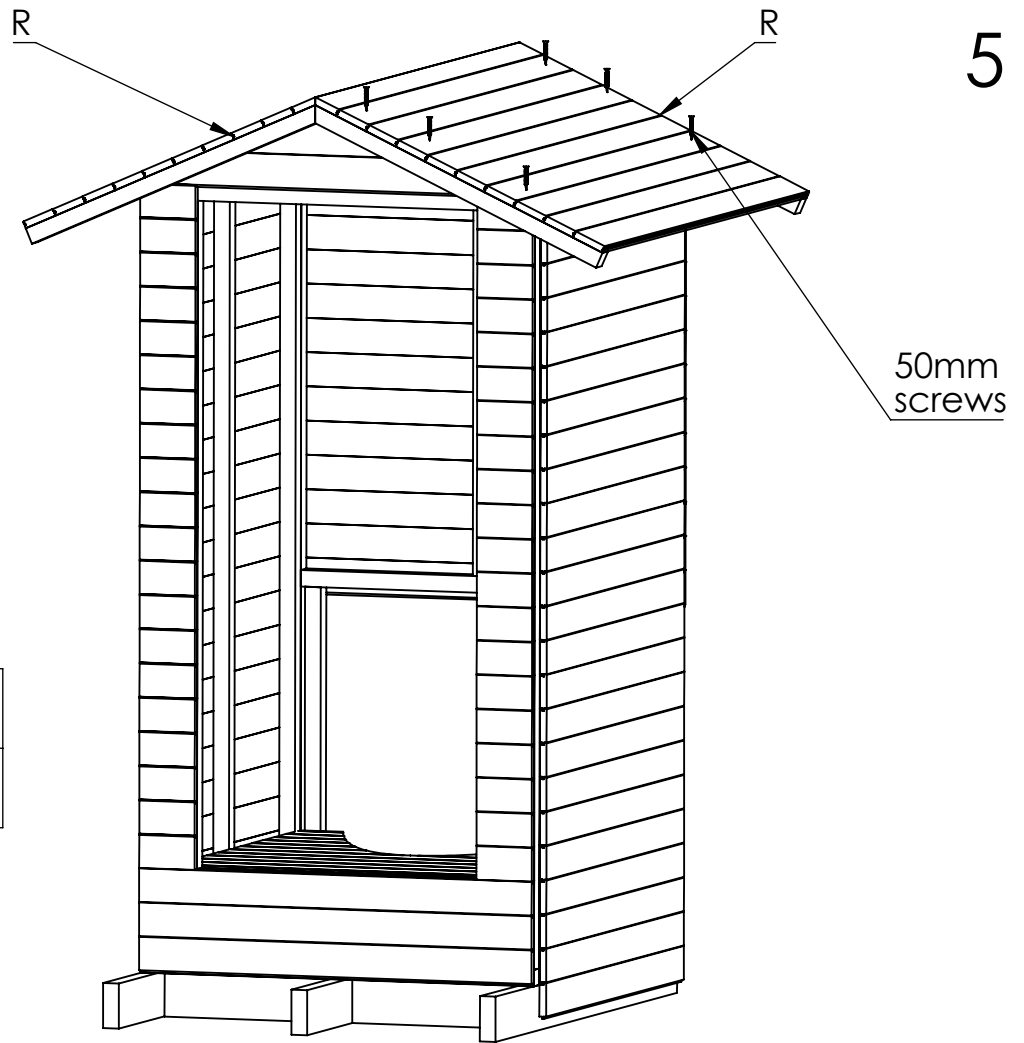

NB! Drill the pilot holes for the screws

R	2
50mm screws	12

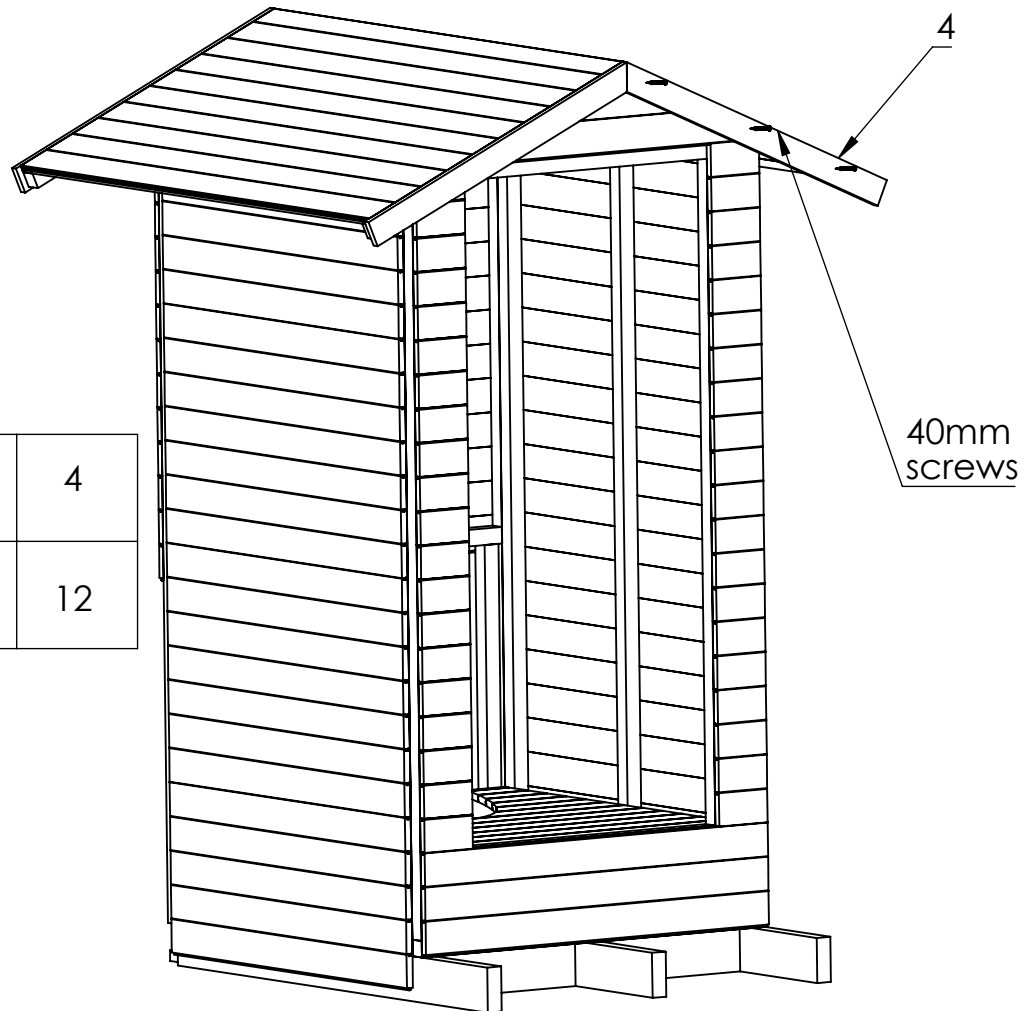

4	4
40mm screws	12

NB! drill the pilot holes for the screws

40mm screws

5

50mm screws

6

5	4
40mm screws	20
6	3
50mm screws	18

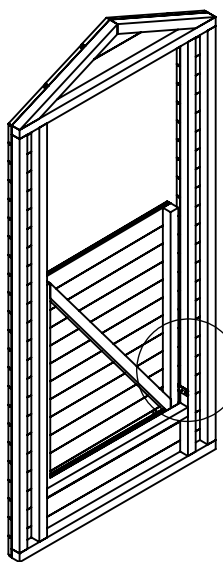
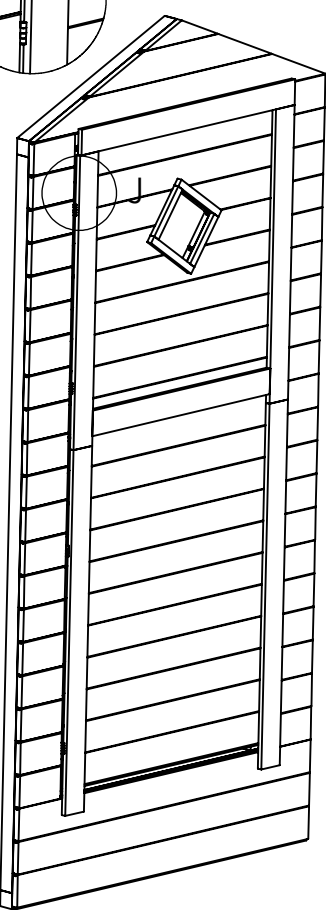
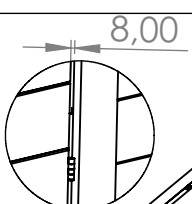
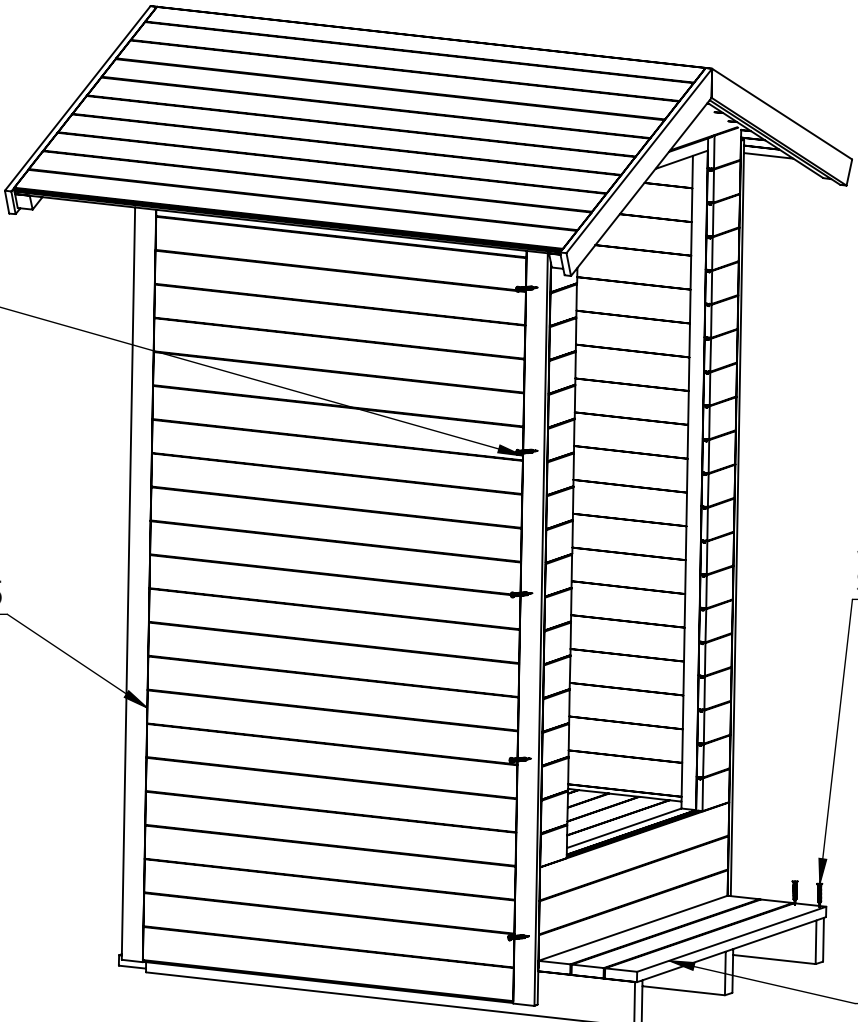

40mm screws

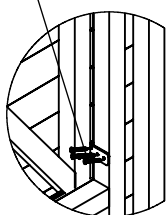

D2	1
hinge	4
40mm screws	32

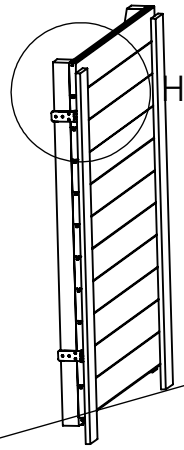

40mm screws

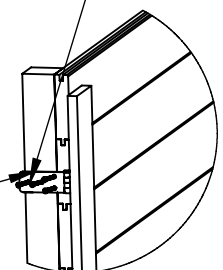

hinge

D1

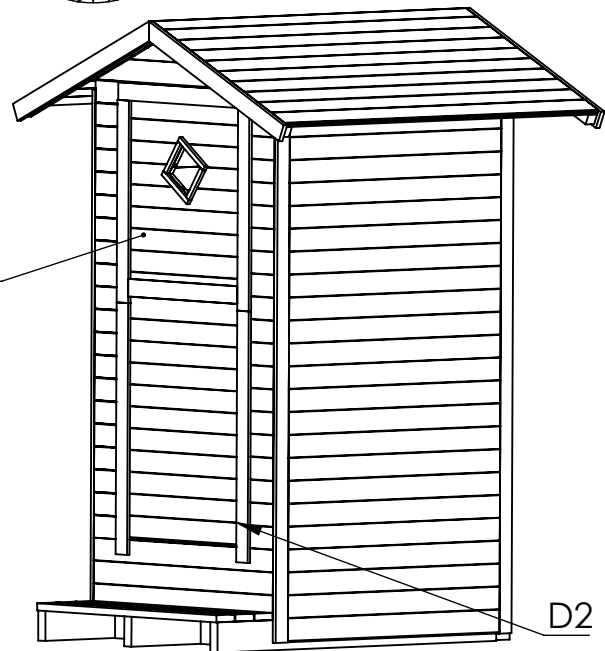

D2